

Steric Effects of Phosphorus Ligands in Organometallic Chemistry and Homogeneous Catalysis[†]

CHADWICK A. TOLMAN

Central Research and Development Department, E. I. du Pont de Nemours and Company, Experimental Station, Wilmington, Delaware 19898

Received June 2, 1976 (Revised Manuscript Received September 10, 1976)

Contents

I. Introduction	313
A. Definition of Electronic and Steric Effects	314
B. The Electronic Parameter ν	314
C. The Steric Parameter Θ	314
D. Limitations of the Molecular Models	315
II. Structures of Real Ligands and Complexes	316
III. Spectroscopic Properties and Electron Distributions	319
A. NMR Chemical Shifts and Coupling Constants	319
B. Infrared Frequencies and Intensities	323
C. Electronic Spectra	324
D. Electric and Magnetic Dipole Moments	324
E. Electrochemistry and ESR	324
F. Ionization Potentials of Free Ligands	324
IV. Rates and Equilibria	325
A. Dissociation of Phosphorus Ligands	325
B. Dissociation of Other Ligands	325
C. Metal–Metal Bond Cleavage	326
D. Associative Reactions	326
E. Ligand Exchange Equilibria	327
F. Oxidative Addition Reactions	328
G. Isomerism	330
V. Unusual Reactions and Products	334
A. Displacement of Other Ligands	334
B. Unusual Complexes of Arenes, Tetramethylethylene, CO ₂ , N ₂ , and Hydrides	335
C. Unusual Coordination Numbers	335
D. Products with Unusual Structures	335
E. Unusual Oxidation States	336
VI. Homogeneous Catalysis	337
A. Reaction Rates	337
B. Product Distributions	337
C. Asymmetric Induction	338
VII. Steric and Electronic Map	339
VIII. Steric Effects of Other Ligands	340
IX. Summary	341
X. Addendum	341
XI. Appendixes	343
XII. References	346

I. Introduction

It has long been recognized that changing substituents on phosphorus ligands can cause marked changes in the behavior of the free ligands and of their transition metal complexes. Prior to 1970, nearly everything was rationalized in terms of electronic effects, although there were scattered references to steric effects. In that year, quantitative measures of electronic¹ and steric² effects were proposed—based on A₁ carbonyl stretching frequencies (ν) in Ni(CO)₃L complexes, and ligand cone angles (Θ) of space-filling CPK molecular models.³ Since then a large

number of papers have appeared which show that steric effects are generally at least as important as electronic effects and can dominate in many cases. Molecular structures, rate and equilibrium constants, NMR chemical shifts, and even relative infrared intensities have been correlated with ligand cone angles.

There have been no reviews of phosphorus ligand steric effects, though Pidcock⁴ did devote a short section to the subject in his chapter in "Transition Metal Complexes of Phosphorus, Arsenic and Antimony Ligands", published in 1973. For background reading on steric effects in organic chemistry, the reader should see books by Brown⁵ and Taft.⁶ I have not attempted a comprehensive coverage of the literature but rather have selected works, published through 1975, which best illustrate the basic principles. Though phosphorus ligands are of primary interest, I have included some data on ligands coordinated by As, Sb, and Bi. For the convenience of the reader, values of ν and Θ are tabulated in Appendixes A and B. For purposes of comparison, Appendix C gives cone angles for a few ligands of other types, such as H, halogen, alkyl, acyl, CO, and π -C₅H₅.

Abbreviations used include:

Me	methyl
Et	ethyl
Pr	propyl
Bu	butyl
Ph	phenyl (ϕ = Ph in figures)
Ar	aryl
Bz	benzyl
Cy	cyclohexyl
Np	naphthyl
Cp	cyclopentadienyl
Pz	pyrazolyl
Tol	tolyl
L	any monodentate phosphorus ligand
dmpe	Me ₂ PCH ₂ CH ₂ PMe ₂
p ₃	CH ₃ C(CH ₂ PPh ₂) ₃
X	an anionic ligand, generally a halogen
DH	dimethylglyoximate
TPP	tetraphenylporphyrin
salen	<i>N,N'</i> -ethylenebis(salicylideneiminato)
μ -CO	a bridging carbonyl
acacen	<i>N,N'</i> -ethylenebis(acetylacetoniminato) (see 41)
diop	2,3- <i>O</i> -isopropylidene-2,3-dihydroxy-1,4-bis(diphenylphosphino)butane (see 92)
ν	$\nu_{\text{CO}}(\text{A}_1)$ of Ni(CO) ₃ L in CH ₂ Cl ₂ in cm ⁻¹
Θ	the ligand cone angle in degrees
δ	an NMR chemical shift
Δ	coordination chemical shift ($\delta_{\text{complex}} - \delta_{\text{free}}$)
μ	an electric dipole moment
$E_{1/2}$	a half-wave potential in electron volts
D	Debyes
BM	Bohr magnetons
S	any substituent on phosphorus

[†] In honor of Professor Richard C. Lord on the occasion of his 65th birthday.

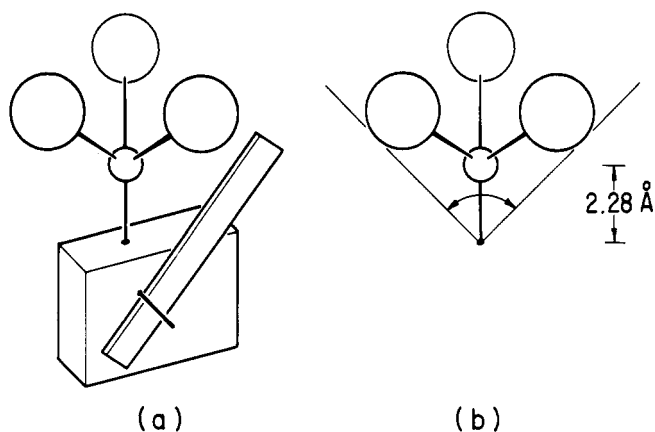

Figure 4. (a) Ligand angle measuring device; (b) the cone angle, from ref 2.

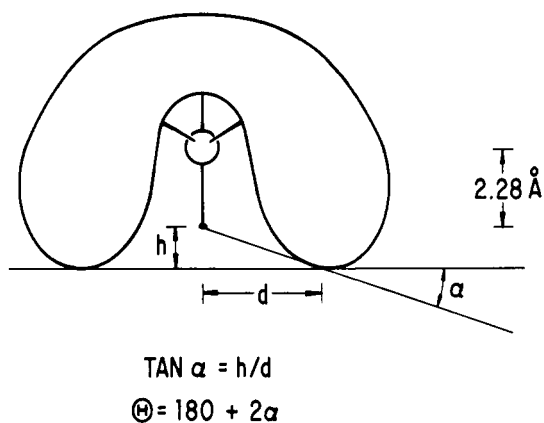
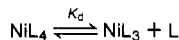

Figure 5. Method of measuring cone angles larger than 180° .

TABLE II. Equilibrium Constants^a in Benzene at 25° :



L	K_d , M	Original θ , ^b deg	New θ , deg
P(OEt) ₃	$< 10^{-10}$ ^c	109	109
PMe ₃	$< 10^{-9}$ ^c	118	118
P(O- <i>p</i> -C ₆ H ₄ Cl) ₃	2×10^{-10}	~121	128
P(O- <i>p</i> -Tol) ₃	6×10^{-10}	~121	128
P(O- <i>i</i> -Pr) ₃	2.7×10^{-5}	114	130
PEt ₃	1.2×10^{-2}	132	132
P(O- <i>o</i> -Tol) ₃	4.0×10^{-2}	~165	141
PMePh ₂	5.0×10^{-2}	^d	136
PPh ₃	^e	145	145

^a Selected values from ref 9. ^b From ref 2. ^c At $+70^\circ\text{C}$. ^d θ for unsymmetrical ligands was not defined in ref 2. ^e No Ni(PPh₃)₄ was detected in solution; ref 58.

In the case of chelating diphosphines, $\theta_i/2$ can be taken as the angle between one M-P bond and the bisector of the PMP angle.⁹

A much better correlation of binding ability of ligands on Ni(0) with θ is shown in Figure 7. [The values of θ used (Appendix B) are not in all cases those reported originally.]

There is an approximate group additivity relationship for cone angles of unsymmetrical PX₁X₂X₃ ligands, which assumes that $\theta_i/2$ will be the same as in PX₃. Physically this means that the orientation of substituent X_i which minimizes θ in eq 2 will be the same which minimizes θ of PX₃. Mathematically, θ for PMePh₂ is two-thirds of the way between PMe₃ (118°) and PPh₃ (145°) or 136°.

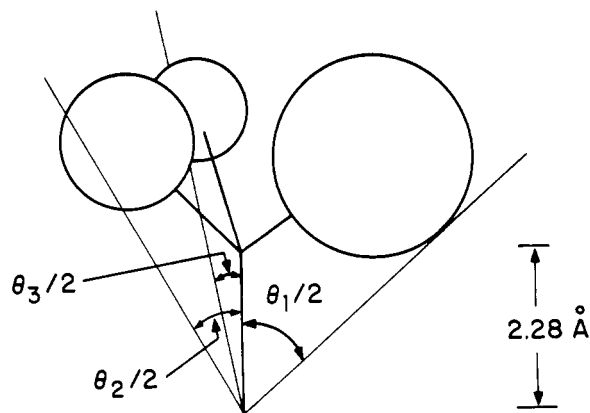

Figure 6. Method of measuring cone angles for unsymmetrical ligands.

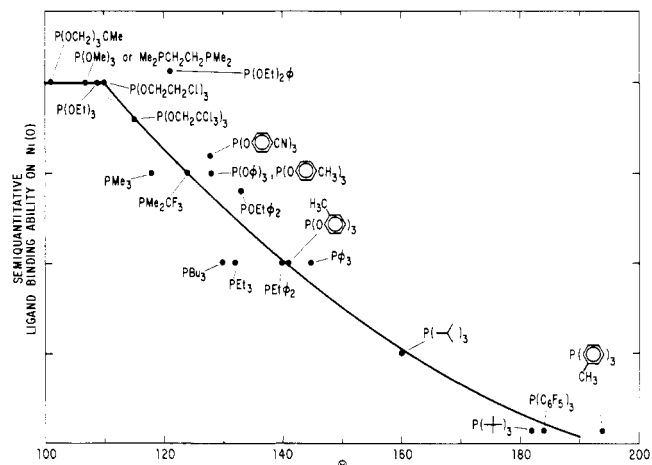

Figure 7. The data from Figure 2 plotted against θ from Appendix B.

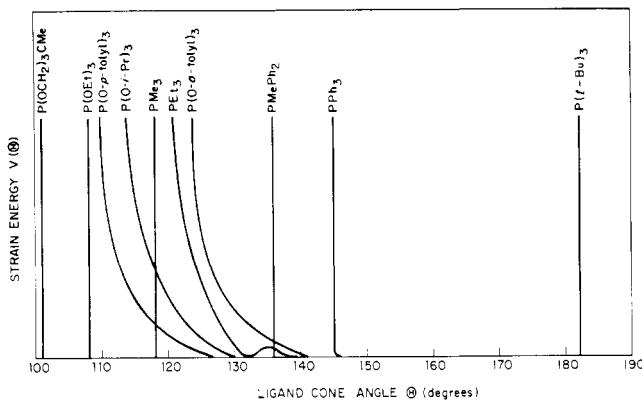

Figure 8. Strain energy in phosphorus ligand models as the ligand cone is compressed, from ref 9.

D. Limitations of the Molecular Models

For ligand models with fixed geometries [such as pf₃, P(OCH₂)₃CMe, or P(*t*-Bu)₃], or with only a few internal degrees of freedom (PMe₃ or PPh₃), θ can be rapidly and confidently measured to $\pm 2^\circ$. With more complex ligands, it may be difficult to decide when a minimum cone has been reached. It may be possible, as shown in Figure 8, to get still smaller angles by introducing strain (indicated by nonparallel faces between atoms). The question arises: How much strain in a model is realistic in terms of the behavior of real molecules? To answer, we must turn to chemical experiments.

NiL₄ dissociation equilibrium constants (Table II) show that K_d is not sensitive to changing para substituents in aryl phos-

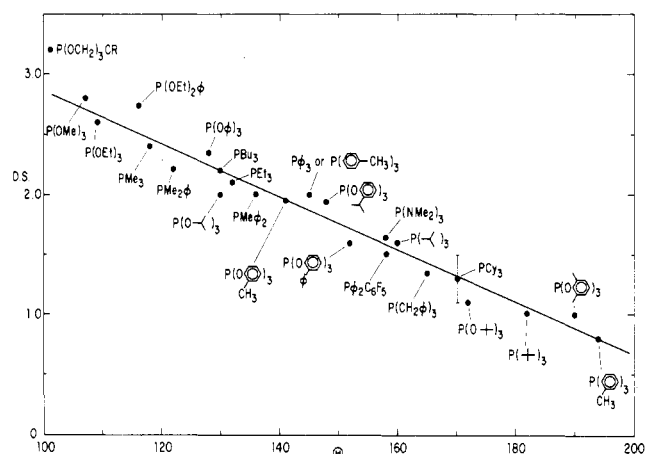

Figure 9. The degree of substitution (DS) of carbonyl groups from $\text{Ni}(\text{CO})_4$, as described in ref 2 and 10.

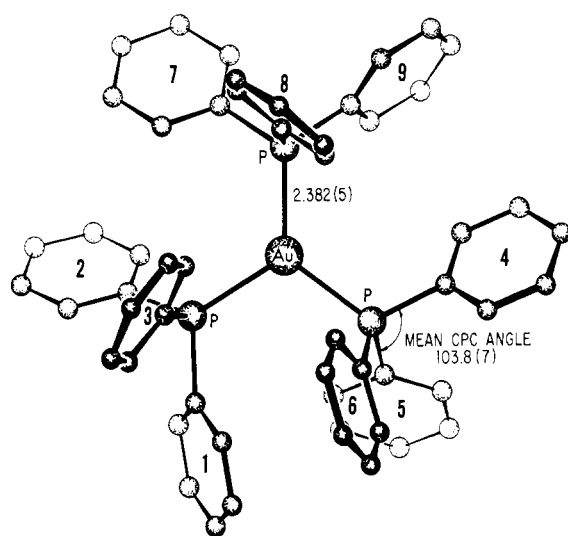

Figure 10. Structure of $\text{Au}(\text{PPh}_3)_3^+$, from ref 11.

phites. If we assume that steric effects dominate, the original values of Θ are clearly not in the right order for the experimental K_d : $\text{PPh}_3 > \text{P}(\text{O}-o\text{-Tol})_3$ and $\text{P}(\text{O}-i\text{-Pr})_3 > \text{P}(\text{O}-p\text{-Tol})_3$. Closer inspection of the models shows that 114° for $\text{P}(\text{O}-i\text{-Pr})_3$ requires a great deal of strain; an unstrained value is near 130° . The 165° for $\text{P}(\text{O}-o\text{-Tol})_3$ was measured² with all three methyl groups pointing toward P; pointing them away gives an essentially strain-free model at 141° . The similarity of K_d 's for PMePh_2 and $\text{P}(\text{O}-o\text{-Tol})_3$ and the fact K_d is larger for $\text{P}(\text{O}-p\text{-Tol})_3$ than for PMe_3 suggest that strain-free models give a more realistic picture of the size of real ligands.

In cases where Θ is difficult to measure with models, a value can be estimated from a simple experiment in which $\text{Ni}(\text{CO})_4$ is heated with an eightfold excess of L in a sealed tube.¹⁰ The degree of substitution (DS) of CO by L can be readily estimated from the IR spectrum in the carbonyl region.² Figure 9 shows the rather good correlation of DS with Θ , larger ligands replacing fewer CO's. The value of 1.25 for PCy_3 is the average of three determinations, with the average deviation indicated by error bars. On this basis, PCy_3 can be assigned a cone angle of 170° , rather than the original model-based value² of $179 \pm 10^\circ$. Several other types of experiments to be described also show that PCy_3 is significantly smaller than $\text{P}(t\text{-Bu})_3$, which has an accurately measurable $\Theta = 182^\circ$. It is such revised values of Θ which appear in Appendix B.

One difficulty with the ligand cone idea is that even symmetric real ligands do not have cylindrical symmetry. They can mesh into one another and achieve higher coordination numbers than

TABLE III. SPS Angles^a

L			
PH_3			
93.8			
PF_3	$\text{Ni}(\text{PF}_3)_4$	$\text{H}_3\text{B}\cdot\text{PF}_3$	OPF_3
96.3	98.4	100	101.3
$\text{P}(\sigma\text{-C}_6\text{H}_4)_3\text{P}$			$\text{OP}(\sigma\text{-C}_6\text{H}_4)_3\text{PO}$
97.0 ^b			100.5 ^b
PMe_3			OPMe_3
98.9			~106
$\text{P}(\text{OCH}_2)_3\text{CH}_2\text{Br}$			$\text{OP}(\text{OCH}_2)_3\text{CMe}$
100.1 ^c			103.7 ^d
PCl_3			OPCl_3
100			103.8
PPh_3	$\text{Au}(\text{PPh}_3)_3^+$		OPPh_3
103	103.8 ^e		107
$\text{P}(t\text{-Bu})_3$	$\text{NiP}(t\text{-Bu})_3\text{Br}_3^-$		
105.7 ^f	107.0 ^g		

^a From ref 12 unless noted otherwise. ^b D. Schomburg and W. S. Sheldrick, *Acta Crystallogr., Sect. B*, **31**, 2427 (1975). ^c D. S. Milbrath, J. P. Springer, J. C. Clardy, and J. G. Verkade, *J. Am. Chem. Soc.*, **98**, 5493 (1976). ^d D. M. Nimrod, D. R. Fitzwater, and J. G. Verkade, *ibid.*, **90**, 2780 (1968). ^e Reference 11. ^f Estimated from ^{31}P NMR data in ref 53. ^g Reference 24.

might be expected. The meshing of three PPh_3 's ($\Theta = 145^\circ$) in a plane occurs in the structure¹¹ of $\text{Au}(\text{PPh}_3)_3^+$ (Figure 10); there are graphite-like interactions (about 3.4 Å spacings) between rings 1 and 6, 4 and 9, and 2 and 7.

Cone angles of the CPK models are based on a 2.28 Å M-P bond length and on tetrahedral angles about phosphorus. In real molecules both parameters are likely to vary. We have found, however, that variations in M-P or P-C bond lengths in the models of 0.1 Å seldom change Θ by more than 3 or 4°—not much more than the uncertainties in the measurements, and certainly not enough to cause gross distortions in the steric scale. Real M-P bond lengths vary from about 2.12 [$\text{Ni}(\text{PF}_3)_4$] to 2.55 Å [$\text{WCl}_4(\text{PMe}_2\text{Ph})_2$] in a recent tabulation of structures;¹² 2.28 Å is about in the middle of the range. In any case, one is usually comparing complexes of one metal, where the metal covalent radius is fixed.

Angles between substituents on real phosphorus ligands are generally less than tetrahedral and can be changed by crowding, as we shall see in the next section, which describes steric effects on structures.

II. Structures of Real Ligands and Complexes

Angles between substituents on trivalent phosphorus (SPS angles) are invariably less than 109.5° , as seen in the first column of Table III, but approach tetrahedral as the substituents increase in size. Coordination to a transition metal, BH_3 , or O usually opens the angle by 3 or 4°.

This opening can be seen in the structure of $\text{P}(\text{CH}_2\text{O})_3\text{PFe}(\text{CO})_3\text{P}(\text{CH}_2\text{O})_3\text{P}$ ¹³ in Figure 11. Notice that the carbonyl groups bend away from the larger PC_3 ligand ($\Theta = 114^\circ$, determined by the methylene hydrogens) toward the smaller PO_3 ($\Theta = 101^\circ$). The Fe- PO_3 bond is also shorter by 0.07 Å, but it is unclear to what extent the effect is steric or electronic. The same problem arises in the structures of $\text{Cr}(\text{CO})_5\text{PPh}_3$ and $\text{Cr}(\text{CO})_5\text{P}(\text{OPh})_3$, where the Cr-P bond lengths differ by 0.11 Å (2.422 and 2.309 Å).¹⁴ In both Cr complexes, the four equatorial carbonyl groups are bent toward the axial CO to give average angles of about 88.5° .

The M-P bond is 0.075 Å shorter (2.406 vs. 2.481 Å) in *trans*- $\text{CpMo}(\text{CO})_2[\text{P}(\text{OMe})_3]$ ¹⁵ than in *trans*- $\text{CpMo}(\text{CO})_2(\text{PPh}_3)$.¹⁶ More electronegative substituents on P are expected to give a shorter M-P bond because they put more phosphorus s character into the bond. This is nicely shown by the 0.07-Å contraction (2.265 to 2.191 Å) in the Fe-P distance on going from

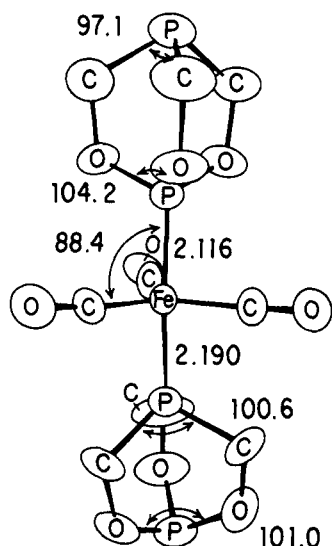

Figure 11. Structure of $P(CH_2O)_3PFe(CO)_3P(CH_2O)_3P$, from ref 13.

TABLE IV

Compound	$d(\text{Co-P}), \text{Å}$
$\text{CpNi}(\mu\text{-CO})_2\text{Co}(\text{CO})_2\text{PEt}_3$	2.236 (1) ^a
$\text{CpNi}(\mu\text{-CO})_2\text{Co}(\text{CO})_2\text{P}(p\text{-C}_6\text{H}_4\text{F})_3$	2.242 (3) ^b
$\pi\text{-MeC}_5\text{H}_4\text{Ni}(\mu\text{-CO})_2\text{Co}(\text{CO})_2\text{PPh}_2\text{Cy}$	2.269 (2) ^c

^a F. S. Stephens, *J. Chem. Soc., Dalton Trans.*, 1067 (1974). ^b I. L. C. Campbell and F. S. Stephens, *ibid.*, 340 (1975). ^c I. L. C. Campbell and F. S. Stephens, *ibid.*, 337 (1975).

$\text{CpFe}(\text{CO})_2\text{P}(\text{CF}_3)_2$ to its oxide $\text{CpFe}(\text{CO})_2\text{P}(\text{O})(\text{CF}_3)_2$.¹⁷ [The CPC angle opens from 94.5 (3) to 96.4 (3)°.]

The substituents on the phosphorus atoms of **1**¹⁸ are similar in size, but very different electronically. The $\text{Pt-P}(\text{CF}_3)_2$ bond is

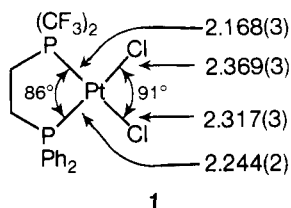

shorter by 0.07 Å and its trans Pt-Cl bond by 0.05 Å. These effects must be largely electronic. A very similar structure was found for the Pd analogue.¹⁹

A role for steric effects is, however, evident in Table IV, where the Co-P bond lengths increase in the order of ligand size, not electron-acceptor character.

Data for a pair of electronically similar complexes **2** ($\text{R} = \text{Me}$ or Et) are given in Table V. The more bulky ethyl ligand gives longer M-P bonds (as much as 0.03 Å) and longer M-Br (as much as 0.12 Å). The cis PMP and Br(2)MP angles increase by as much as 4°.

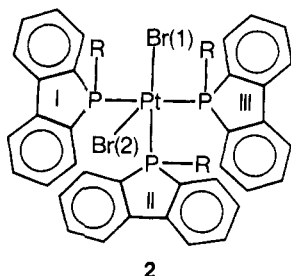

Table VI shows the effects of changing phosphorus substituents on the structures of some Cu(I) complexes. Going from

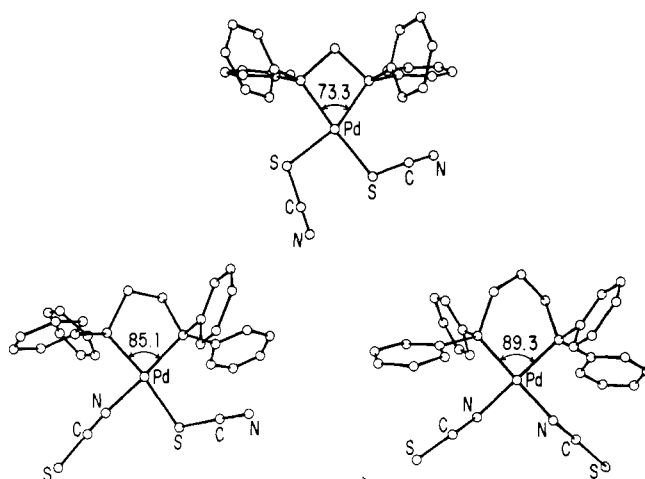

Figure 12. Structures of $[\text{Ph}_2\text{P}(\text{CH}_2)_n\text{PPh}_2]\text{Pd}(\text{SCN})_2$ complexes, from ref 20.

TABLE V. Structural Data^a on Square-Pyramidal 5-Alkyl-5*H*-dibenzophosphole Complexes (**2**)

	Bond Lengths, Å	
	R = Me	R = Et
M-P(I)	2.312 (5)	2.342 (5)
M-P(II)	2.248 (6)	2.257 (5)
M-P(III)	2.306 (6)	2.309 (5)
M-Br(1)	2.534 (3)	2.542 (3)
M-Br(2)	3.026 (3)	3.143 (3)
	Angles, Deg	
P(I)MP(II)	98.40 (19)	98.55 (18)
P(I)MP(III)	168.57 (19)	166.87 (17)
P(II)MP(III)	92.62 (20)	93.01 (20)
Br(2)MP(I)	85.90 (14)	86.21 (13)
Br(2)MP(II)	108.34 (15)	
Br(2)MP(III)	88.09 (5)	

^a K. M. Chui and H. M. Powell, *J. Chem. Soc., Dalton Trans.*, 1879 (1974).

TABLE VI. Structural Data^a on Cu(I) Complexes

Complex	Dist $\text{Cu-P}, \text{Å}$	$\angle\text{PCuP}, \text{deg}$
$\text{Cu}(\text{NO}_3)(\text{PPh}_3)_2$	2.25	131.2 (1)
$\text{Cu}(\text{NO}_3)(\text{PCy}_3)_2$	2.29	140 (1)
$\text{Cu}(\text{B}_3\text{H}_8)(\text{PMePh}_2)_2$	2.25, 2.26	128 (1)
$\text{Cu}(\text{B}_3\text{H}_8)(\text{PPh}_3)_2$	2.27, 2.29	120.0 (1)

^a S. J. Lippard and G. J. Palenik, *Inorg. Chem.*, **10**, 1322 (1971).

PPh_3 to PCy_3 in the nitrate complexes increases the Cu-P distance by 0.04 Å and the PCuP angle by 9°. Going from PMePh_2 to PPh_3 in the borane complexes increases the distances by only about 0.02 Å. In this case, the interaction with the borane is more important than between the phosphines, and the larger phosphine has a *smaller* PMP angle. (The PMePh_2 ligands have their smaller Me groups toward the B_3H_8 .)

Palenik and co-workers²⁰ have reported a nice example of steric effects on structure in the series $[\text{Ph}_2\text{P}(\text{CH}_2)_n\text{PPh}_2]\text{-Pd}(\text{SCN})_2$ with $n = 1, 2, \text{ or } 3$, shown in Figure 12. Not only does the PMP angle increase with increasing n , but the binding mode of the thiocyanates goes from N,N to N,S to S,S.

The 0.06-Å longer M-P distance in *trans*- $\text{PtI}_2(\text{PCy}_3)_2$ than in *trans*- $\text{PtBr}_2(\text{PEt}_3)_2$ (Table VII) has been attributed to greater steric crowding in the iodide complex. [The Pt-I distance is slightly longer (0.014 Å) than the value calculated from the Pt-Br distance and the difference in covalent radii of I and Br.] The shorter Pt-P distance in *trans*- $\text{H}_2\text{Pt}(\text{PCy}_3)_2$ approaches that in $\text{Pt}(\text{PCy}_3)_2$.

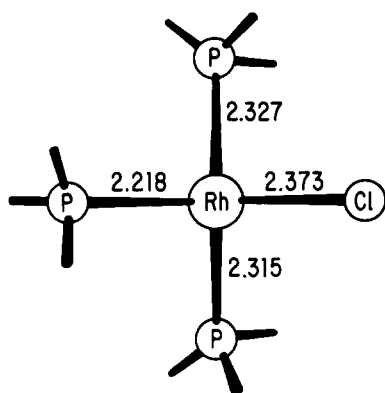
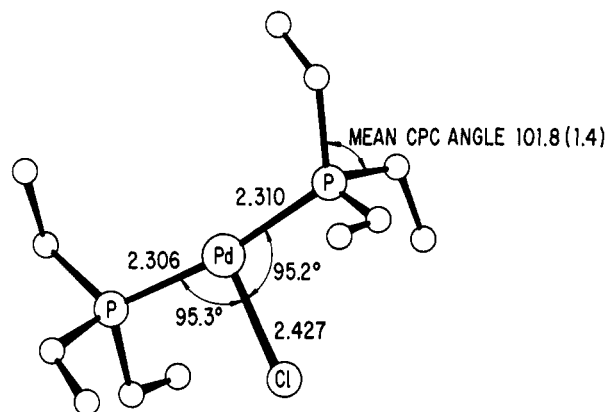
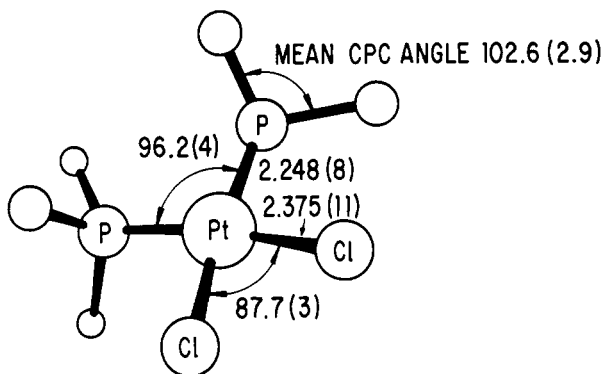
Figure 13. Structure of $\text{RhCl}(\text{PPh}_3)_3$, from ref 26.Figure 15. Structure of *trans*- $\text{HPdCl}(\text{PEt}_3)_2$, from ref 32.Figure 14. Structure of *cis*- $\text{PtCl}_2(\text{PMe}_3)_2$, from ref 28.TABLE VII. Pt-P Distances in *trans*- PtX_2L_2 Complexes

Complex	$d(\text{Pt}-\text{P})$, Å	Ref
$\text{Pt}(\text{PCy}_3)_2$	2.231 (4)	23
$\text{H}_2\text{Pt}(\text{PCy}_3)_2$	2.25 (1)	22
$\text{PtBr}_2(\text{PEt}_3)_2$	2.315 (4)	21
$\text{PtI}_2(\text{PCy}_3)_2$	2.371 (2)	21

The unusually crowded molecule $\text{NiP}(t\text{-Bu})_3\text{Br}_3^-$ ²⁴ shows an exceptionally long Ni-P bond of 2.48 (1) Å, 0.20 Å longer than the more normal value of 2.28 Å in NiPPh_3 ²⁵. Average Br-Ni-Br and INi angles are 108.7 and 114.0°, respectively. The mean CPC angle of 107.0° in $\text{NiP}(t\text{-Bu})_3\text{Br}_3^-$ is one of the largest reported for a phosphine complex. An even larger value of 114.5° in $\text{HP}(t\text{-Bu})_3^+$ in the same crystal has been attributed²⁴ to the much smaller steric requirements of -H compared to -NiBr₃. This example does illustrate how the geometry within a phosphine can be significantly altered by contacts with other atoms in a complex. The P(*t*-Bu)₃ cone angle of 184 ± 2° in the anion, determined from the x-ray structure, is in good agreement with the 182° measured using CPK models.

There are many examples of structures where deviations from idealized geometries are attributable to steric effects. One example is the nonplanar arrangement of the heavy atoms in $\text{RhCl}(\text{PPh}_3)_3$ ²⁶ (Figure 13). The short Rh-P bond trans to Cl reflects a reduced trans influence of Cl relative to P (certainly an electronic effect), and results in a greater $^1J_{\text{RhP}}$ in the ³¹P NMR spectrum.²⁷ The heavy atoms are also not coplanar in *cis*- $\text{PtCl}_2(\text{PMe}_3)_2$ ²⁸ (Figure 14). Steric crowding between the two phosphines is more severe than between the two halogens. The Pt-P length is 0.03 Å longer than in $\text{PtCl}_3(\text{PEt}_3)^-$,²⁹ where the deviations from an idealized square-planar geometry are much less (mean ClPtCl angle 89.4 (2)°).

The crystal structure of $\text{Ir}(\text{PMePh}_2)_4^+$ shows a large tetrahedral distortion away from the idealized square plane.^{30a} Significantly, the compound does not react with O₂ or CO, although the closely

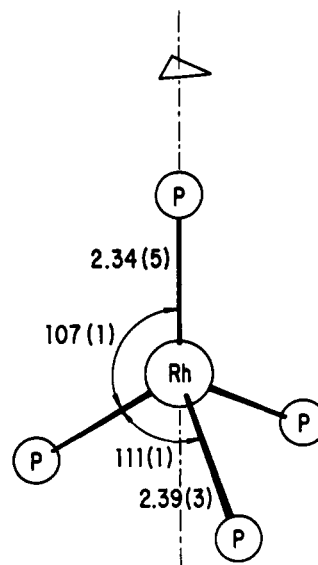
Figure 16. Structure of $\text{HRh}(\text{PPh}_3)_3$, from ref 33. The H presumably lies on the three-fold axis below the Rh.

analogous but less crowded $\text{Ir}(\text{Ph}_2\text{PCH}_2\text{CH}_2\text{PPh}_2)_2^+$ does, as does $\text{Ir}(\text{PMe}_2\text{Ph})_4^+$. The x-ray structure of both dioxygen complexes have been determined.^{30b}

It is common in hydride complexes to find distortions away from idealized geometries because of bending of ligands toward the less sterically demanding hydride.³¹ An example is *trans*- $\text{HPdCl}(\text{PEt}_3)_2$ ³² (Figure 15). The phosphines have rotated to minimize interaction of the methylene groups with the Cl. Going to *trans*- $\text{HPdCl}[\text{P}(i\text{-Pr})_3]_2$ increases the mean PMCl angle from 95.3 to 96.3°.³¹ With a smaller metal atom in *trans*- $\text{HNiCl}[\text{P}(i\text{-Pr})_3]_2$, the angle is still larger, 98.3°.³¹

The structure of $\text{HRh}(\text{PPh}_3)_4$ (Figure 16) has a threefold axis, but it is so far distorted from a trigonal bipyramid that it is nearly tetrahedral.³³ In $\text{HRh}(\text{PF}_3)(\text{PPh}_3)_3$, where the smaller PF₃ is trans to H, the average angle between axial and equatorial phosphines is 99.3°.³⁴ Axial-equatorial phosphine angles of 89° are found in **3**.^{35a}

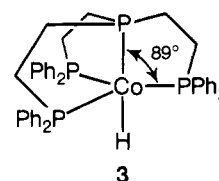

The equatorial CO's in **4** are bent slightly toward the Mn-Mn bond (Table VIII) and staggered to reduce repulsive interactions. Phosphines of moderate bulk replace CO's in the less crowded

TABLE VIII. Structural Data for $\text{Mn}_2(\text{CO})_{10}$ and Its Derivatives

	Mean angle MnMnC, deg	Dist Mn-Mn, Å	Dist MnP, Å
$(\text{CO})_5\text{Mn}-\text{Mn}(\text{CO})_5^a$	86.2 ± 1.4	2.92	
$(\text{CO})_5\text{Mn}-\text{Mn}(\text{CO})_4\text{PMe}_2\text{Ph}^b$	87.5	2.90	2.24
$\text{PMePh}_2(\text{CO})_4\text{Mn}-\text{Mn}(\text{CO})_4\text{P}-\text{MePh}_2^c$	86	2.90	2.23
$\text{PEt}_3(\text{CO})_4\text{Mn}-\text{Mn}(\text{CO})_4\text{PEt}_3^d$	87.6 ± 2.6	2.91	2.25

^a L. F. Dahl and R. E. Rundle, *Acta Crystallogr.*, **16**, 419 (1963). ^b M. Laing, E. Singleton, and R. Reimann, *J. Organomet. Chem.*, **56**, C21 (1973). ^c From ref 35b. ^d M. J. Bennett and R. Mason, *J. Chem. Soc. A*, 75 (1968).

TABLE IX. ^{31}P Chemical Shifts^a of Phosphines

Compound	$\angle\text{SPS}$, ^b deg	$\delta(^{31}\text{P})$, ^c ppm	θ , deg
PH_3	93.8	+240 ^d	87
PMe_3	98.9	+62	118
PEt_3		+20.1	132
PPh_3	103	+6.0	145
$\text{P}(i\text{-Pr})_3$		-20.0 ^e	160
$\text{P}(t\text{-Bu})_3$	105.7 ^f	-63.3	182

^a In ppm upfield of 85% H_3PO_4 . ^b From ref 12. ^c From ref 53, unless noted otherwise. ^d From ref 37, p 238. ^e C. A. Tolman, unpublished result in THF. ^f Estimated from $^1\text{J}_{\text{PC}}$ in ref 53.

axial positions, but seem not to affect the structures much. AsMe_2Ph is sufficiently less sterically demanding than PMePh_2 that the disubstituted complex is diequatorial rather than diaxial.^{35b}

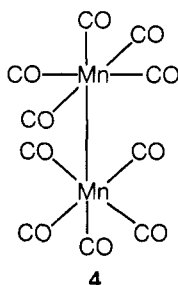

III. Spectroscopic Properties and Electron Distributions

A. NMR Chemical Shifts and Coupling Constants

1. ^{31}P Chemical Shifts

The electronegativity of substituents on phosphorus and the angles between them are the two most important variables determining ^{31}P chemical shifts and coupling constants.³⁶ The large range of phosphine chemical shifts in Table IX is striking, in view of the similar electronegativities of the substituents, but can be understood in terms of opening of SPS angles by steric crowding of the substituents. The cone angles (defined by the outermost edges of the ligands) also increase with the downfield shift of $\delta(^{31}\text{P})$.

Grim's group contributions⁴¹ (GC_i) to ^{31}P chemical shifts of tertiary phosphines (Table X) can be similarly understood, though he first explained them in terms of hyperconjugation.

^{31}P shifts to high field can be anticipated if structural constraints require small CPC angles, as in **5** to **7**. In **8**, where the angles are constrained to 60° , the chemical shift is +450 ppm,⁴⁵ the highest $\delta(^{31}\text{P})$ known.

Chemical shifts of acyclic alkyl phosphites (Table XI) are insensitive to changes in the bulk of the alkyl. The oxygens provide enough flexibility in the free phosphites that the OPO angles can

TABLE X. Grim's Group Contributions^a to $\delta(^{31}\text{P})$

For $\text{PR}_1\text{R}_2\text{R}_3$ $\delta(^{31}\text{P})_{\text{calcd}} = \sum_{i=1}^3 \text{GC}_i$			
R_i	GC_i	R_i	GC_i
Me	21	c-C ₅ H ₉	0
Neopentyl	18	Cy	-2
<i>i</i> -Bu	15	<i>sec</i> -Bu	-3
Pr, Bu	11	<i>i</i> -Pr	-6
Et	7	<i>t</i> -Amyl	-21
Bz	4	<i>t</i> -Bu	-23
Ph	3		

^a From ref 41.

TABLE XI. ^{31}P Chemical Shifts^a of Phosphites

Compound	$\angle\text{OPO}$, deg	$\delta(^{31}\text{P})$, ^c ppm	θ , deg
$\text{P}(\text{OCH}_2)_3\text{CMe}$	100.1 ^b	-90.9 ^d	101
$\text{P}(\text{OMe})_3$		-139.7	107
$\text{P}(\text{OEt})_3$		-137.6	109
$\text{P}(\text{O}-i\text{-Pr})_3$		-137.5	130
$\text{P}(\text{O}-t\text{-Bu})_3$		-138.1 ^e	172

^a Negative values are ppm downfield from 85% H_3PO_4 . ^b Angle for $\text{P}(\text{OCH}_2)_3\text{CCH}_2\text{Br}$ from Table III. ^c From G. A. Olah and C. W. McFarland, *J. Org. Chem.*, **36**, 1374 (1971), except where noted otherwise. ^d From ref 2. ^e Neat liquid; C. A. Tolman, unpublished result.

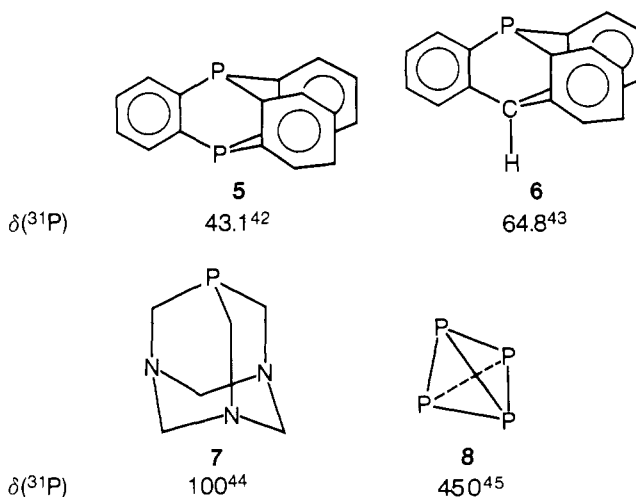

remain essentially constant. The strained bicyclic phosphite, however, is ~ 50 ppm to higher field. Verkade⁴⁶ believes that this is not due to an unusually small OPO angle in the cage. Unfortunately, accurate OPO angles for the acyclic phosphites are not available.⁴⁷ A 50-ppm chemical shift difference for phosphites corresponds to a change in OPO angle of about 3° .⁴⁸

Gorenstein⁴⁹ has recently proposed an empirical correlation between ^{31}P chemical shifts of phosphates and OPO bond angles. The correlation is, however, not monotonic.

Coordination chemical shifts ($\Delta = \delta_{\text{complex}} - \delta_{\text{free}}$) depend on the nature of the metal and on the change in SPS angles on coordination.⁵⁰ Angle opening on coordination is consistent with the usually observed downfield shift (negative Δ). The magnitude of Δ tends to be less for larger ligands, as seen for *trans*- $\text{RhCl}(\text{CO})\text{L}_2$ complexes in Figure 17. This is because SPS angles of ligands with large substituents generally open less on coordination.

In chelating diphosphine complexes, Δ depends on ring size (Table XII). Large downfield shifts are general for five-membered chelate rings.⁵¹ If a phosphorus is part of two or three five-membered rings as in **9** and **10**, more negative values of Δ (in parentheses) can be found.⁵²

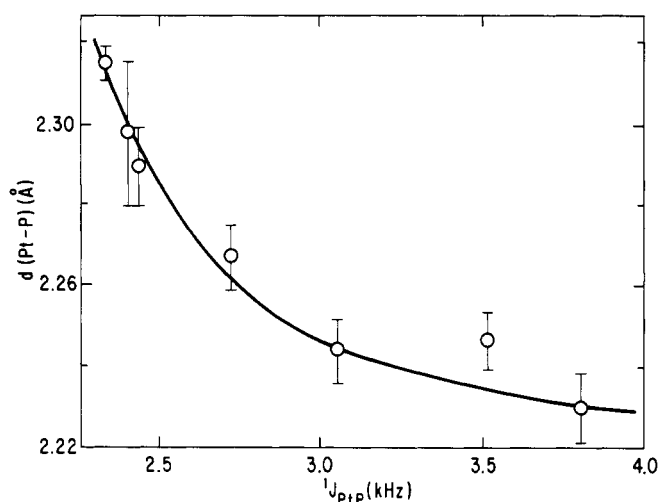

Figure 19. Correlation of $d(\text{Pt}-\text{P})$ with $^1J_{\text{PtP}}$ in Pt(II) and Pt(IV) complexes of PEt_3 and PBU_3 , from ref 55.

judging from a good correlation of $^1J_{\text{WP}}$ with the frequency of the strongest ν_{CO} band (Table XVI). Steric effects in their study may be masked, however, by the large uncertainties in $^1J_{\text{WP}}$ and by the limited range of cone angles employed (130 – 157°).

Pidcock and co-workers⁵⁵ have shown a good inverse correlation (Figure 19) between $^1J_{\text{PtP}}$ and Pt–P bond lengths in PEt_3 and PBU_3 complexes of Pt(II) and Pt(IV). They suggest that the decreasing $^1J_{\text{PtP}}$ for PEt_3 trans to Cl in **11** to **13** may be due primarily to steric distortions.

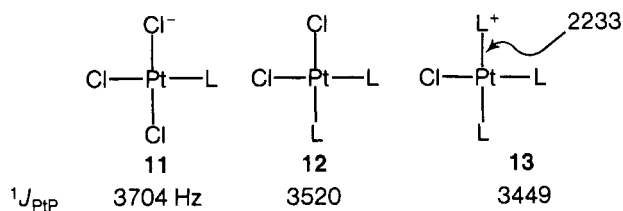
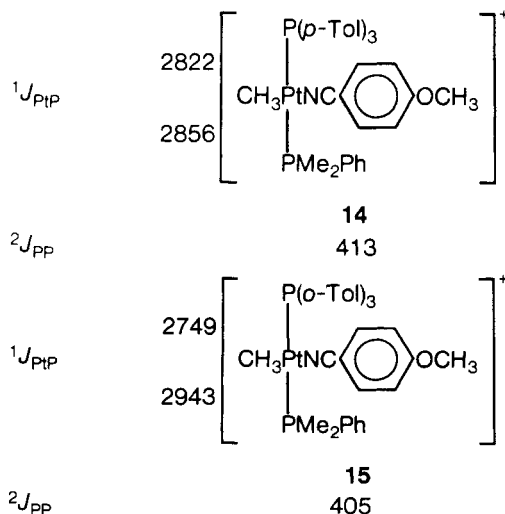

Table XVII shows substantially smaller $^1J_{\text{PtP}}$ for PEt_3 than for PMe_3 in the crowded PtX_2L_2 complexes. $^2J_{\text{PP}}$ is always ~ 70 Hz less for PEt_3 .

The coupling constants⁵⁶ in **14** and **15** show similar effects. Here the weakening of the upper Pt–P bond on going from $\text{P}(p\text{-Tol})_3$ to $\text{P}(o\text{-Tol})_3$ is reflected in a strengthening of the lower one. The changes in $^1J_{\text{PtP}}$ (from Figure 19) correspond to changes in bond length of 0.004 Å.



Values of $^2J_{\text{PP}}$ in $\text{M}(\text{CO})_4\text{L}_2$ complexes have been correlated with the electronegativity of atoms attached to P.⁵⁷ However, the absolute values of $^2J_{\text{PP}}$ in *cis*- $\text{M}(\text{CO})_4\text{L}_2$ complexes con-

TABLE XVI. NMR and IR Data^a for $\text{LW}(\text{CO})_5$ Complexes

L	$^1J_{\text{WP}}$ (± 8 Hz)	Strongest ν_{CO} (± 1 cm^{-1})
PPh_3	280	1942
PBU_3	250	1938
PMePh_2	245	1939
$\text{PPh}_2(t\text{-Bu}), \text{PPh}_2(i\text{-Pr}), \text{PEtPh}_2$	240	1937, 1937, 1938
PBU_2Ph	235	1937
PBU_3	200	1934

^a From ref 54. See also J. G. Verkade, *Coord. Chem. Rev.*, **9**, 1 (1972).

TABLE XVII. NMR Coupling Constants^a

Complex	X	$^1J_{\text{PP}}$, Hz		$^2J_{\text{PP}}$, Hz	
		PMe_3	PEt_3	PMe_3	PEt_3
<i>trans</i> - PtX_4L_2	Cl	1516	1461	660	587
	Br	1550	1471	645	574
<i>trans</i> - PtX_2L_2	Cl	2379	2408	510	436
	Br	2336	2336	514	449

^a R. J. Goodfellow and B. F. Taylor, *J. Chem. Soc., Dalton Trans.*, 1676 (1974).

taining P–NR₂ groups were too small, tentatively attributed to opening of the PMP angles by steric interactions.

Metal–phosphorus coupling constants depend on structural constraints in chelates (see Table XII). A marked effect can be seen in comparing **16**, **17**, and **18**. The PPTP angles in the triphosphine of **18** are all restricted to $\sim 90^\circ$, tending to concen-

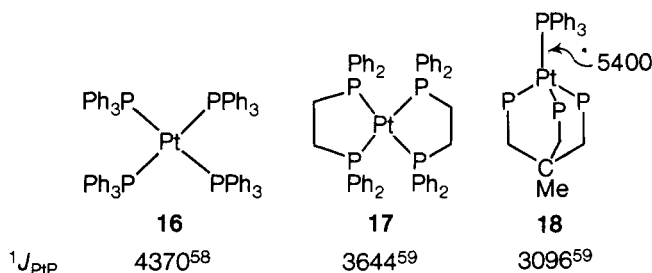

trate Pt s character in the fourth Pt–P bond. It is noteworthy that **18** is dissociatively stable up to 60°C whereas **16** is completely dissociated to $\text{Pt}(\text{PPh}_3)_3$ and PPh_3 at $+25^\circ\text{C}$.⁵⁸

The small value of $^1J_{\text{PtP}}$ ⁵⁹ in **21** is due to the small PPTP angle of 73° .⁶⁰ The Pt–P bond lengths [2.30 (1) Å] are normal.

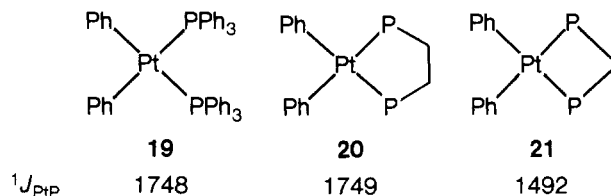

3. ^1H Chemical Shifts and Coupling Constants

Perhaps the most surprising steric effect on ^1H NMR chemical shifts is shown (Figure 20) by the methanol protons in the $[(\text{CH}_3\text{OH})\text{Co}(\text{DH})_2\text{L}]^+$ complexes of Trogler and Marzilli.⁶¹ Near independence of electronic effects is suggested by the similar shifts for $\text{P}(\text{CH}_2\text{CH}_2\text{CN})_3$ and PBU_3 ($\nu = 2077.9$ and 2060.3 cm^{-1} , respectively). There seems to be little steric effect until θ reaches $\sim 120^\circ$, presumably where the interaction with the planar dimethylglyoximate ligand becomes important. The authors have tried to fit their data with a model which assumes that the increased shielding for larger L arises from a distortion of the ring from planarity, but the calculated shifts are much smaller

TABLE XXI. Infrared Stretching Frequencies of ν_{IrH} in $\text{HIrCl}_2(\text{CO})_2\text{L}_2$ Complexes

L	ν_{IrH} , cm^{-1}	L	ν_{IrH} , cm^{-1}
PMe_3	2169	$\text{PPr}_2(t\text{-Bu})$	2242
PMe_2Ph	2191	$\text{PBu}_2(t\text{-Bu})$	2244
$\text{PMe}_2(t\text{-Bu})$	2208	$\text{PMe}(t\text{-Bu})_2$	2254
PMePh_2	2217	PCy_3^b	2276
$\text{PEt}_2(t\text{-Bu})$	2227	$\text{PEt}(t\text{-Bu})_2$	2300
PPh_3	2237	$\text{PPh}(t\text{-Bu})_2$	2300

^a From ref 67 unless noted otherwise. ^b F. G. Moers, J. A. M. deJong, and P. M. H. Beaumont, *J. Inorg. Nucl. Chem.*, **35**, 1915 (1973).

TABLE XXII. P=O Stretching Frequencies in Oxides

Compound	$\nu_{\text{P=O}}$, cm^{-1}
$\text{OP}(\text{OCH}_2)_3\text{CC}_5\text{H}_{11}$	1327 ^a
$\text{OP}(\text{OBu})_3$	1260 ^b
$\text{OP}(\text{-C}_6\text{H}_4)_3\text{N}$	1250 ^c
$\text{OP}(\text{-C}_6\text{H}_4)_3\text{CH}$	1240 ^d
$\text{OP}(\text{-C}_6\text{H}_4)_3\text{PO}$	1233 ^e
OPPh_3	1195 ^f

^a L. J. Vande Griend and J. G. Verkade, private communication from Verkade. ^b S. C. Goodman and J. G. Verkade, *Inorg. Chem.*, **5**, 498 (1966).

^c D. Hellwinkel and W. Schenk, *Angew. Chem. Int. Ed. Engl.*, **8**, 987 (1969).

^d Reference 43. ^e Reference 42. ^f F. A. Cotton, R. D. Barnes, and E. Bannister, *J. Chem. Soc.*, 2199 (1960).

B. Infrared Frequencies and Intensities

Changes in bonding as a result of increasing ligand size can be expected to affect vibrational spectra. One of the most striking examples is Shaw's⁶⁷ observation of an increase in ν_{IrH} in the series of complexes of type **27** in Table XXI.

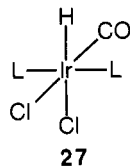

The equilibrium constant for going to the six-coordinate complex (**27**) in eq 3 decreases as L becomes larger,⁶⁷ even though some of the larger ligands are better donors. Apparently the IrH bond becomes stronger going down the table; the Ir-P bonds must become weaker in the same order.

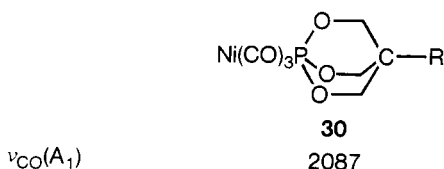
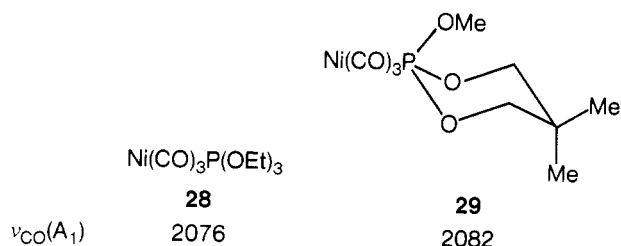

The carbonyl stretching frequencies in **28**, **29**, and **30** show the effect of increasing constraints on reducing the metal

TABLE XXIII. Relative IR Intensities^a in $\text{Mn}_2(\text{CO})_9\text{L}$

L	I_1/I_2	L	I_1/I_2
PF_3	0.05	PBu_3	0.3
$\text{P}(\text{OPh})_3$	0.3	PPh_3	0.6

^a J. P. Fawcett, A. J. Poë, and M. V. Twigg, *J. Organomet. Chem.*, **61**, 315 (1973).

TABLE XXIV. Angles (α) between CO Groups, and CO Stretching Force Constants in $\text{PzB}(\text{Pz})_3\text{Mn}(\text{CO})_2\text{L}$ Complexes^a

L	α , deg	k_{CO} , $\text{mdyn}/\text{\AA}$
PCl_3	44.4	15.54
$\text{P}(\text{OPh})_3$	45.6	15.06
PBu_3	46.9	14.46
PPh_3	43.8	14.60
PCy_3	42.7	14.40

^a From ref 69.

electron density in Ni(0) compounds.⁶⁸ (This is also reflected in a reduced basicity of the NiL_4 complexes toward H^+ .)

The P=O stretching frequencies of the oxides of phosphorus ligands (Table XXII) show similar effects. Note the decrease in frequency in the triptycene derivatives as the covalent radius of the bridgehead atom is increased in size.

The relative IR intensities of the two highest frequency carbonyl stretching modes ν_1 and ν_2 in $\text{Mn}_2(\text{CO})_9\text{L}$ depend on the size of L (Table XXIII). The larger ligands may increase the PMnC angle.



Schoenberg and Anderson⁶⁹ have used the relative intensities of symmetric and asymmetric carbonyl vibrations in $\text{PzB}(\text{Pz})_3\text{-Mn}(\text{CO})_2\text{L}$ complexes to calculate angles (α) between the CO groups (Table XXIV). Larger ligands decrease α , increasing the symmetric to asymmetric intensity ratio. The CO force constants show the expected dependence on electronic effects.

Steric effects can change the number of bands observed in the IR. $\text{M}(\text{CO})_5\text{L}$ complexes of Cr, Mo, and W show a single E carbonyl mode (at about 1945 cm^{-1}) when $\text{L} = \text{P}(p\text{-Tol})_3$ or $\text{P}(m\text{-Tol})_3$. With $\text{P}(o\text{-Tol})_3$, however, the band is split into a doublet with a separation of $\sim 10 \text{ cm}^{-1}$.⁶³

The $\text{Ni}(\text{CN})_2\text{L}_3$ complex ($\text{L} = 5\text{-methyl-5H-dibenzophosphole}$, **31**) shows three CN stretching bands in its mull IR spectrum at

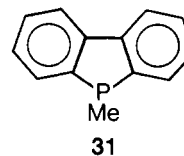

2118, 2108, and 2102 cm^{-1} .⁷⁰ Its 5-ethyl analogue shows only one, at 2118. The UV absorption spectra of the crystals are also very different. A single-crystal x-ray study shows that the compounds have different stereochemistries: square pyramidal **32** (5-Me) and trigonal-bipyramidal **33** (5-Et).

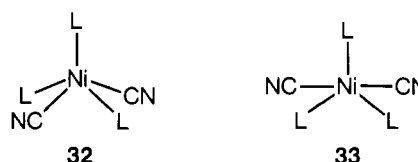

TABLE XXV. Effect of Replacing P(*n*-Pr)₃ by P(*i*-Pr)₃ on Spectra of *trans*-NiX₂L₂^a

Band	-Δν, cm ⁻¹		
	X = NCS	Cl	Br
III	600	1400	1750
IV		1250	1350

^a From ref 72.

C. Electronic Spectra

Dobson, Stolz, and Sheline, in their review of group 6B metal carbonyl derivatives, point out that derivatives with small phosphines are often colorless, while those of larger ones are yellow.^{71a} The deepening of color of [(CH₃OH)Co(DH)₂L]⁺ complexes as the size of L increases was mentioned previously.

Bennett and co-workers^{71b} found a red shift of the lowest frequency ligand field band in *trans*-[CrL₂(NCS)₄]²⁻ complexes in a sequence which must involve ligand size: PMe₃ (19 950), PEt₃ (19 500), and PEt₂Ph (19 050 cm⁻¹). Complexes with bulkier ligands PPh₃ and PCy₃ could not be made.

Electronic transitions of *trans*-NiX₂L₂ complexes show a marked red shift when P(*n*-Pr)₃ is replaced by P(*i*-Pr)₃. The frequencies of bands III and IV at ~25 000 and ~19 000 cm⁻¹ decrease by an amount which depends on X (Table XXV). The shift is greater for larger X. The authors⁷² attribute the shifts to lengthening of the Ni-X bonds. A similar red shift has been reported more recently for the lowest frequency transition in tetrahedral NiBr₂L₂ complexes: PMePh₂ (11 680), PEtPh₂ (11 360), and PPh₂(*t*-Bu) (10 800 cm⁻¹); here, however, the effect was attributed to lengthening Ni-P bonds.⁷³ Probably both occur.

The complexes NiCl₂(PEt₃)₂, NiBr₂(PEt₃)₂, and NiCl₂(PCy₃)₂ are red while NiBr₂(PCy₃)₂ is olive green; all are diamagnetic in the solid state.⁷⁴

Ligand size can also affect the electronic spectra of NiX₂L₂ complexes in solution by shifting the square-planar-tetrahedral equilibrium, to be discussed in section IV.G.2.

Larger ligands also dissociate more readily, as we shall see in section IV.A. Thus, Ni(PMe₃)₄ is a light yellow crystalline solid and gives light yellow benzene solutions. Ni(PEt₃)₄ crystals look very similar but give permanganate violet solutions, because of a high concentration of NiL₃.⁹ Similarly Ni(Me₂PCH₂CH₂PMe₂)₂ is light yellow⁹ while Ni(Cy₂PCH₂CH₂PCy₂)₂ is violet;⁷⁵ one end of the bulky diphosphine remains uncoordinated, even in the solid.

trans-PdI₂(PMe₂Ph)₂ exists in two crystalline modifications, one yellow (34) and one red (35).⁷⁶ 35 shows much shorter ortho H-Pd distances (2.84 vs. 3.28 Å).

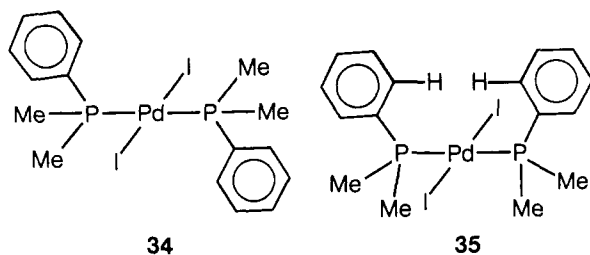

D. Electric and Magnetic Dipole Moments

The electric dipole moment of paramagnetic NiI₂(PPh₃)₂ is 8.5 D, much larger than the 5.9 D of NiBr₂(PPh₃)₂.⁷⁷ This result cannot be explained in terms of the electronegativities of the halogens, but is consistent with a greater tetrahedral distortion with the larger halide.

A similarly anomalous trend is seen in the *trans*-CH₃Pt(PEt₃)₂X

TABLE XXVI. Percent s Character in Co(II) Complexes by ESR

L	Co(TPP)L ^a	Co(salen)L ^b
PF ₃	68	
P(OMe) ₃	55	49
P(OEt) ₃	51	
P(OBu) ₃	48	
PMe ₃	36	33
PHMe ₂	34	
PBu ₃	31	
PMe ₂ Ph	28	
PEt ₃	27	
PPh ₃		24

^a B. B. Wayland and M. E. Abd-Elmageed, *J. Am. Chem. Soc.*, **96**, 4809 (1974). ^b B. B. Wayland, M. E. Abd-Elmageed, and L. F. Mehne, *Inorg. Chem.*, **14**, 1456 (1975).

TABLE XXVII. UV Photoelectron Data on Gaseous Ligands

L	IP ₁ , eV	L	IP ₁ , eV
PH ₃	10.58 ^a	PBu ₃	8.11 ^b
P(OCH ₂) ₃ Ce ^t	9.8 ^b	P(<i>i</i> -Pr) ₃	8.05 ^b
P(OMe) ₃	9.25 ^a	P(<i>t</i> -Bu) ₃	7.71 ^b
PMe ₃	8.65 ^a	P(<i>m</i> -C ₆ H ₄ F) ₃	8.32 ^c
P(vinyl) ₃	8.48 ^b	PPh ₃	7.92 ^c
PEt ₃	8.31 ^b	P(<i>p</i> -C ₆ H ₄ OCH ₃) ₃	7.48 ^c

^a O. Stelzer and E. Unger, *Chem. Ber.*, **108**, 1246 (1975). ^b M. A. Weiner and M. Lattman, private communication from Weiner. ^c M. A. Weiner, M. Lattman, and S. O. Grim, *J. Org. Chem.*, **40**, 1292 (1975).

series where μ = 3.4 D (Cl), 3.7 (Br), and 4.1 (I), or in *trans*-EtPt(PEt₃)₂X, where μ = 3.7 (Cl) and 4.15 (I).⁷⁸ The anomaly should be small or absent in *trans*-CH₃Pt(PMe₃)₂X. An effect of P-Pt angle on electric dipole moment is seen in comparing *cis*-Ph₂Pt(PEt₃)₂ (7.2) and *cis*-Ph₂Pt(Et₂PCH₂CH₂PEt₂) (8.4 D).⁷⁸

The magnetic dipole moment of NiP(*t*-Bu)₃₃⁻ (3.07 BM) is anomalously small when compared to NiPPh₃₃⁻ (3.46).⁷⁹ The corresponding complexes with the smaller bromide ion, which are less crowded, show essentially the same moments for P(*t*-Bu)₃ (3.73) and PPh₃ (3.68) complexes.⁸⁰

E. Electrochemistry and ESR

Steric effects in electrochemistry have barely been explored. Baird^{81a} has found that the Co(III) complexes Co(salen)L₂⁺ and Co(DH)₂L₂⁺ become easier to reduce in the order of increasing ligand size: PMe₂Ph < PBu₃ < PMePh₂ < PPh₃.

Electrochemical studies on oxidation of M(CO)₂[Ph₂P-(CH₂)_nPPh₂]₂ (M = Cr, Mo, W) show that the complexes with n = 1 are more easily oxidized than those with n = 2.⁸²

ESR studies on Co(II) phosphine complexes (Table XXVI) show that the percent s character in the P-donor orbital generally increases with more electronegative substituents on P. Large substituents, however, show abnormally low s character, most clearly seen for PPh₃.

F. Ionization Potentials of Free Ligands

The advent of UV photoelectron spectroscopy has made it possible to measure ionization potentials with high accuracy. The first ionization potential (IP₁) of free phosphorus ligands nearly always arises from the phosphorus lone pair. It might be expected that electron-withdrawing groups would increase IP₁, which is indeed the case (Table XXVII). Going from P(*p*-C₆H₄OCH₃)₃ to P(*m*-C₆H₄F)₃ increases IP₁ by 0.84 eV. The data in Table XXVII suggest, however, that there is also an important steric effect on IP₁. Thus, the ionization potential decreases in the series PMe₃, P(vinyl)₃, and P(*m*-C₆H₄F)₃ even though the substituents on P become more electronegative. This and the

TABLE XXVIII. Equilibrium Constants^a in CH₃CN at 60 °C for the Reaction
$$\text{CpMo}(\text{CO})_2\text{LCOCH}_3 \xrightleftharpoons{K} \text{CpMo}(\text{CO})_3\text{CH}_3 + \text{L}$$

L	$K \times 10^4, \text{M}$	L	$K \times 10^4, \text{M}$
PMe ₂ Ph	0.1	PPh ₃	8.3
PBu ₃	0.3	PCy ₃	50
PMePh ₂	1.3	PPh ₂ (<i>i</i> -Pr)	90
P(<i>p</i> -C ₆ H ₄ OCH ₃) ₃	5.3	P(<i>o</i> -Tol)	<i>b</i>
P(<i>p</i> -Tol) ₃	6.1		

^a From ref 86. ^b Very large.

TABLE XXIX. Equilibrium Constants^a in 95% EtOH at 25 °C for the Reaction:
$$\text{Co}(\text{salen})\text{L}_2^+ \xrightleftharpoons{K} \text{Co}(\text{salen})\text{L}^+ + \text{L}$$

L	$K \times 10^4, \text{M}$	L	$K \times 10^4, \text{M}$
PMe ₂ PH	0.13	PMePh ₂	9.1
PBu ₃	3.7	PPh ₃	610

^a From ref 81.

marked decrease in IP₁ in the series PH₃, PMe₃, PEt₃, P(*i*-Pr)₃, and P(*t*-Bu)₃ can be largely attributed to the decreasing percentage of *s* character in the lone pair as larger substituents force open the SPS angles. The high ionization potential of P(OCH₂)₃CEt relative to P(OMe)₃ is consistent with a smaller OPO angle in the cage.

IV. Rates and Equilibria

Ligand size can have a marked influence on rates and equilibria. This section will emphasize quantitative solution studies on simple reactions. Section V deals with the isolation of unusual complexes and section VI with homogeneous catalytic systems.

A. Dissociation of Phosphorus Ligands

We saw earlier (Table II) that steric effects dominate the dissociation equilibria of NiL₄ complexes. K_d at 25 °C increases by a factor of 10⁸ on going from P(*o*-*p*-Tol)₃ to P(*o*-*o*-Tol)₃, an increase in Θ from 128 to 141°. This corresponds to a decrease in ΔH_d of 10 kcal/mol.⁹ The rates of L dissociation also show a steric effect; k_d is 100 to 1000 times faster for P(*o*-*o*-Tol)₃ than for P(*o*-*p*-Tol)₃ at 25 °C. Electronic effects are also important; phosphines dissociate faster from Ni(0) than phosphites of similar size.⁹

Musco and co-workers^{83,84} have studied the equilibria

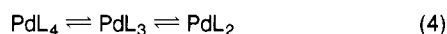

and find that the extent of L dissociation is dominated by steric effects, increasing in the order PMe₃ ~ PMe₂Ph ~ PMePh₂ < PEt₃ ~ PBu₃ ~ PPh₃ < PBz₃ < P(*i*-Pr)₃ < PCy₃ < PPh(*t*-Bu)₂.³¹ P NMR studies⁸⁴ also show steric effects on the rates of exchange of free and coordinated phosphines.

Vapor pressure osmometry shows that L dissociation from CuXL₃ (X = halogen) increases in the steric order PMe₂Ph ~ PMePh₂ < PPh₃ and AsMe₂Ph < AsMePh₂.⁸⁵ CuX(AsPh₃)₃ could not be made.

Equilibrium constants of Barnett and Pollmann⁸⁶ for L dissociation from CpMo(CO)₂LCOCH₃ are shown in Table XXVIII. P(*o*-Tol)₃, the largest ligand used in the study, is completely dissociated.

Equilibrium constants for L dissociation from Co(salen)L₂⁺ (Table XXIX) show a larger steric effect; K increases by a factor of 4700 from PMe₂Ph to PPh₃. Activation energies for disso-

TABLE XXX. Relative Rate Constants^a in CHCl₂CHCl₂ at 40 °C for the Reaction:
$$\text{cis-Mn}(\text{CO})_4\text{BrL} \xrightarrow{k} \text{Mn}(\text{CO})_3\text{BrL} + \text{CO}$$

L	k_{rel}	L	k_{rel}
P(OBu) ₃	0.3	PBu ₃	1.3
SbPh ₃	0.6	AsPh ₃	2.3
P(OPh) ₃	0.6	PPh ₃	8.4
CO	(1.0)		

^a J. D. Atwood and T. L. Brown, *J. Am. Chem. Soc.*, **98**, 3155 (1976).

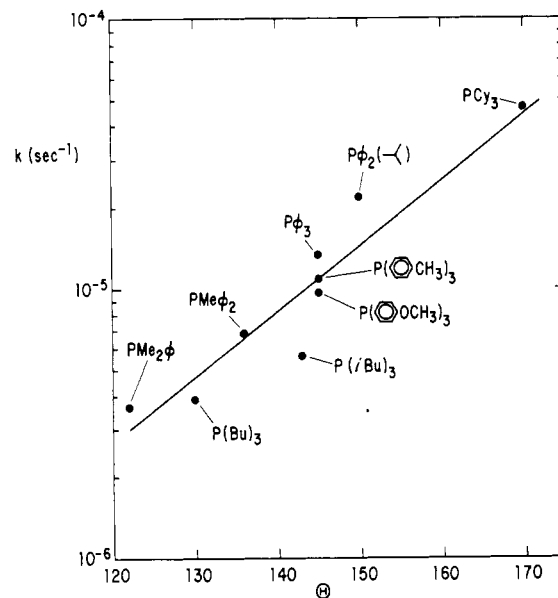
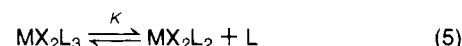

Figure 22. Rate constants in CH₃CN at 60 °C for the reaction: CpMo(CO)₂(L)COCH₃ → CpMo(CO)₂(L)CH₃ + CO, from ref 86.

ciation (24.7 kcal/mol for PMe₂Ph and 14.9 for PMePh₂ (determined by NMR line shapes) show a marked steric labilization.⁸¹

Rates of dissociation of HCoL₄ complexes increase in the steric order P(OMe)₃ < P(OEt)₃ < P(OPh)₃,⁸⁷ equilibrium mixtures in competition experiments strongly favor the smaller phosphines.

Rigo and Turco⁸⁸ have concluded that steric effects dominate equilibria of type



where M = Ni or Co and X = CN or halogen. We have confirmed this in the nickel dicyanide system and find that K_5 increases in the sequence PMe₃ < PEt₃ < PCy₃.⁸⁹

The extent of L dissociation will, of course, depend on the steric requirements of the other ligands in a complex. We find a reduced tendency to dissociate L in the analogous HNiL₃CN complexes,⁹⁰ presumably because H is less sterically demanding than CN. The extent of phosphine dissociation is less for HRuCl(PPh₃)₃ than for RuCl₂(PPh₃)₃,⁹¹ presumably for a similar reason.

B. Dissociation of Other Ligands

CO substitution in *cis*-MnBr(CO)₄L involves rate determining loss of the CO *cis* to both Br and L. Relative rates (Table XXX) increase *s* with the size of phosphorus ligand and in the order SbPh₃ < AsPh₃ < PPh₃.

Figure 22 shows the effect of increasing the size of L on the rates of CO dissociation from CpMo(CO)₂LCOCH₃. A small electronic effect is evident in the increase in rate on going from P(*p*-C₆H₄OCH₃)₃ to PPh₃. Rates of chelation of (R₂P-

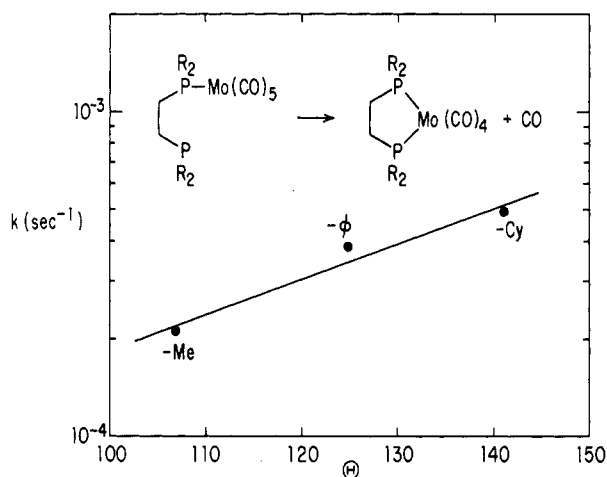
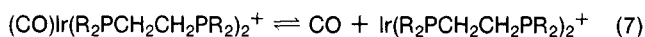
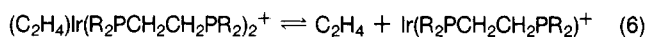

Figure 23. Rate constants for ring closure in nonane at 110 °C, from ref 92.

$\text{CH}_2\text{CH}_2\text{PR}_2\text{Mo}(\text{CO})_5$ complexes⁹² (Figure 23) increase with the size of R, but the slope is less. Steric acceleration can be understood in terms of a rate-determining loss of CO, followed by rapid ring closure. The rates of chelation of $[\text{R}_2\text{P}(\text{CH}_2)_n\text{PR}_2]\text{Cr}(\text{CO})_5$ complexes also depend on the value of n (Table XXXI).

Herskovitz⁹³ has found that the dissociation constants for eq 6 and 7 increase in the sequence $\text{R} = \text{Me} < \text{Et} < i\text{-Pr}$, obviously a case of steric control.



Reversible CO dissociation from $\text{CoX}_2\text{L}_2(\text{CO})$ complexes increases with the size of L (Table XXXII). The dissociation sequence $\text{NCS} < \text{Br} < \text{Cl}$ must involve both electronic and steric factors, since Br is larger than Cl. The authors⁹⁴ argued against steric effects of L on the basis that earlier work⁹⁵ on MX_2L_3 dissociation showed that differences in K were due to differences in ΔH_d , not ΔS_d . We now know that steric effects can have a major influence on ΔH_d .⁹

Steric factors can influence rates of radiation-induced dissociation reactions. Irradiation of **36** in the presence of PPh_3 gives **37** rather than the less crowded **38**,⁹⁶ indicating more rapid

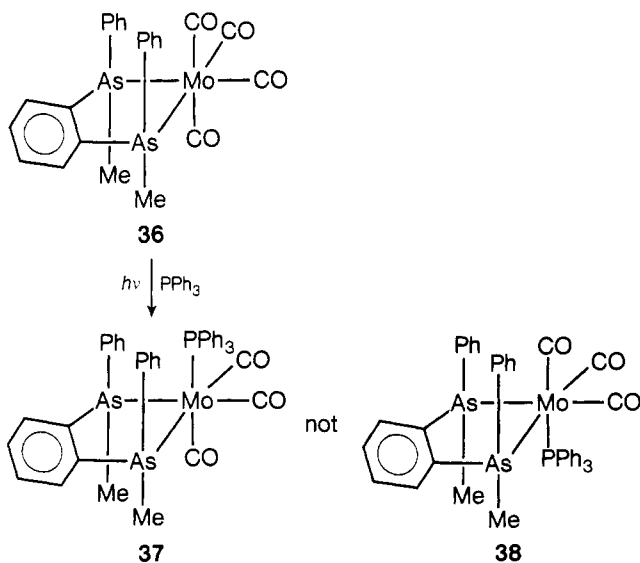

loss of CO from the most hindered position. The preferential kinetically controlled formation of *cis*- $\text{M}(\text{CO})_4\text{L}_2$ complexes in light-induced reactions of $\text{M}(\text{CO})_5\text{L}$ with L may be largely sterically controlled.

TABLE XXXI. Rate Constants^a in *n*-Octane at 124 °C for the Reaction: $(\text{diphosphine})\text{Cr}(\text{CO})_5 \rightarrow \text{CO} + \text{chelated } (\text{diphosphine})\text{Cr}(\text{CO})_4$

Diphosphine	$10^4 k, \text{sec}^{-1}$
$\text{Me}_2\text{PCH}_2\text{CH}_2\text{PMe}_2$	0.75
$\text{Ph}_2\text{PCH}_2\text{CH}_2\text{CH}_2\text{PPh}_2$	26
$\text{Ph}_2\text{PCH}_2\text{CH}_2\text{PPh}_2$	34
$\text{Ph}_2\text{PCH}_2\text{PPh}_2$	55

^a J. A. Connor, J. P. Day, E. M. Jones, and G. K. McEwen, *J. Chem. Soc., Dalton Trans.*, 347 (1973).

TABLE XXXII. Equilibrium Constants^a in $\text{C}_2\text{H}_4\text{Cl}_2$ at 25 °C for the Reaction:

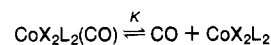

L	$K \times 10^4, \text{M}$		
	X = NCS	Br	Cl
PEt_3		4.0	8.1
$\text{P}(n\text{-Pr})_3$		4.3	12.7
PEt_2Ph		10	500
PEtPh_2	20	97	1470
PPh_3	110	3000	<i>b</i>
PCy_3	450	<i>b</i>	<i>b</i>

^a From ref 94. ^b Very large.

$\text{RuBr}_2[\text{Ph}_2\text{P}(\text{CH}_2)_3\text{PPh}_2]_2$ in 1,2-dichloroethane dissociates to Br^- and $\text{RuBr}[\text{Ph}_2\text{P}(\text{CH}_2)_3\text{PPh}_2]_2^+$. Less crowded $\text{RuX}_2[\text{Ph}_2\text{P}(\text{CH}_2)_n\text{PPh}_2]_2$ complexes with $n = 1$ or 2 do not, nor does the complex with $n = 3$ and $\text{X} = \text{Cl}$.⁹⁷ Attempts to prepare the $n = 4$ complex $\text{RuCl}_2[\text{Ph}_2\text{P}(\text{CH}_2)_4\text{PPh}_2]_2$ failed, giving instead $\text{Ru}_2\text{Cl}_4[\text{Ph}_2\text{P}(\text{CH}_2)_4\text{PPh}_2]_3$.

C. Metal–Metal Bond Cleavage

A special class of dissociation reactions involves cleavage of metal–metal bonds. Drakesmith and Whyman⁹⁸ have found that $\text{Ir}_4(\text{CO})_{12}$ clusters are much more easily broken down under CO and H_2 pressure with $\text{L} = \text{PPh}_3$ or $\text{P}(i\text{-Pr})_3$ than with PEt_3 , PPr_3 , or PBu_3 . Since $\text{Hlr}(\text{CO})_3\text{P}(i\text{-Pr})_3$ forms so easily, the $\text{P}(i\text{-Pr})_3$ system is particularly active in olefin hydroformylation.⁹⁹

RuX_2L_n ($\text{X} = \text{halogen}$, $n = 2, 3$, or 4) complexes participate in several equilibria to form binuclear complexes linked by two or three halide bridges. Only with bulky phosphines such as PPh_3 or $\text{P}(p\text{-Tol})_3$ are the mononuclear species favored; then RuX_2L_4 complexes are completely dissociated in solution to RuX_2L_3 and L.¹⁰⁰

Poë¹⁰¹ has reported that activation energies for homolytic cleavage of the Mn–Mn bond decrease in the sequence $(\text{CO})_5\text{Mn}-\text{Mn}(\text{CO})_5 > (\text{CO})_5\text{Mn}-\text{Mn}(\text{CO})_4\text{L} > \text{L}(\text{CO})_4\text{Mn}-\text{Mn}(\text{CO})_4\text{L}$ and $\text{L} = \text{P}(\text{OPh})_3 > \text{PBu}_3 > \text{PPh}_3$, suggesting a weakening of the metal–metal bond by crowding transmitted through the carbonyls.

Sufficiently large ligands should stabilize odd-electron mononuclear fragments. Indeed, while $[\text{P}(\text{OMe})_3]_4\text{Co}-\text{Co}-[\text{P}(\text{OMe})_3]_4$ is a stable diamagnetic dimer,⁸⁷ $\text{Co}(\text{PMe}_3)_4$ exists as a paramagnetic monomer,¹⁰² as do $\text{Co}[\text{o}-\text{C}_6\text{H}_4(\text{PEt}_2)_2]_2$ ¹⁰³ and $\text{Co}(\text{N}_2)(\text{PPh}_3)_3$.¹⁰⁴ Steric crowding probably accounts for why $\text{V}(\text{CO})_6$ does not dimerize and thus provides one of the rare examples of a stable paramagnetic carbonyl complex.¹⁰⁵ $\text{V}(\text{dmp}_3)_3$ has also been prepared.¹⁰⁶ Steric hindrance to radical recombination is a well-established phenomenon in organic chemistry.¹⁰⁷

D. Associative Reactions

The rate of carbonyl substitution on **39** by L to give **40** in Table XXXIII depends on L and is clearly second order, implying an associative reaction. There is an electronic factor in the rate

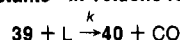
TABLE XXXIII. Rate Constants^a in Toluene for the Reaction:

L	10k, s ⁻¹ M ⁻¹	T, °C
PBu ₃	12.3	30
PEtPh ₂	9.6	35
PHPh ₂	8.5	35
P(OMe) ₃	1.23	35
PPh ₃	0.65	35
PCy ₃	0.58	35
P(OPh) ₃	0.069	35
P(o-Tol) ₃	<i>b</i>	70

^a P. C. Ellgen and J. N. Gerlach, *Inorg. Chem.*, **12**, 2526 (1973). ^b No reaction in 140 h.

TABLE XXXIV. Rate Constants^a in Decalin at 50 °C for the Reaction of Ru₃(CO)₁₂ with L

L	10 ⁴ k ₂ , sec ⁻¹ M ⁻¹	L	10 ⁴ k ₂ , sec ⁻¹ M ⁻¹
PBu ₃	456	P(OPh) ₃	17
P(OEt) ₃	191	PPh ₃	13
P(OCH ₂) ₃ CEt	161	PCy ₃	<1

^a From ref 108.

constants; the phosphites react more slowly than expected on the basis of size alone. P(o-Tol)₃ fails to react at all, even under forcing conditions.

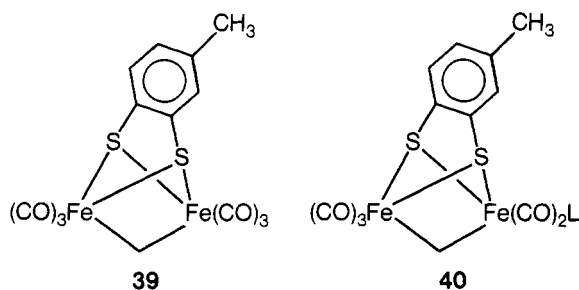

Poë and Twigg¹⁰⁸ have shown that the second-order rate term in the reaction of L with Ru₃(CO)₁₂ (Table XXXIV) depends on both electronic and steric effects. PPh₃ and especially PCy₃ react more slowly than expected on the basis of a plot of log k₂ against half-neutralization potentials. A number of other systems show the same behavior: Co(NO)(CO)₃, Fe(NO)₂(CO)₂, Mn(NO)(CO)₄, CpRh(CO)₂, and M(CO)₆ (M = Cr, Mo, and W).¹⁰⁸

¹H NMR line shape effects indicate slow ligand exchange with HPdCl(PCy₃)₂ but fast exchange with the less crowded HPdCl(PCy₃)(PBu₃) and HPdCl(PBu₃)₂.¹⁰⁹ We have similarly found slow associative exchange of PCy₃ with HNi(PCy₃)₂CN, but a very fast reaction of PEt₃ with HNi(PEt₃)₂CN (by ³¹P NMR).⁹⁰

Competitive rate constants for reactions of the carbene intermediate Fe(CO)₃C(OEt)Me with various L relative to PPh₃ are shown in Table XXXV. The discrimination of this uncrowded species is very small. P(OPh)₃ reacts more slowly than expected on the basis of size alone.

Another type of associative reaction is the formation of carbenes by the reaction of LW(CO)₅ with PhCH₂MgCl (Table XXXVI), where the steric effect is larger (the ratio of PBu₃ to PCy₃ rates is 6.0). For a given L, rates decrease in the order W ≥ Mo > Cr, consistent with more crowding on a smaller metal.

Rates of reaction of LW(CO)₅ with (MeLi)₄ to give cis-LW(CO)₄C(OLi)Me are first order in W and one-fourth order in (MeLi)₄, implying formation of monomeric MeLi prior to nucleophilic attack.¹¹⁰ Rate constants in Table XXXVII show a smaller steric effect than those in Table XXXVI, consistent with the smaller size of MeLi compared to PhCH₂MgCl.

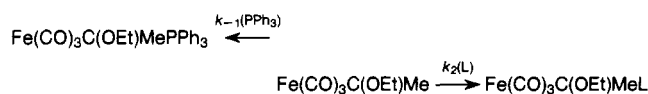
TABLE XXXV. Competitive Rate Constants^a in Heptane at ~70 °C in the Reactions:

L	k ₂ /k ₋₁
PBu ₃	3.0
PCy ₃	1.0
P(OPh) ₃	0.3

^a D. J. Darensbourg and H. L. Conder, *Inorg. Chem.*, **13**, 374 (1974).

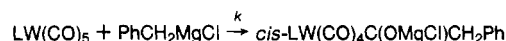
TABLE XXXVI. Rate Constants^a in THF at 27 °C for the Reaction:

L	10 ³ k, s ⁻¹ M ⁻¹	L	10 ³ k, s ⁻¹ M ⁻¹
P(OEt) ₃	25.7	PBu ₃	8.5
PMe ₃	19.1	PPh ₃	5.0
PMe ₂ Ph	14.0	PCy ₃	1.42
PMePh ₂	10.4	P(o-Tol) ₃	1.75 ^b

^a M. Y. Darensbourg, H. L. Conder, D. J. Darensbourg, and C. Hasday, *J. Am. Chem. Soc.*, **95**, 5919 (1973). ^b The product was exclusively the trans isomer.

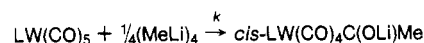
TABLE XXXVII. Rate Constants^a in Et₂O at 25 °C for the Reaction:

L	10 ² k, s ⁻¹ M ^{-1/4}	L	10 ² k, s ⁻¹ M ^{-1/4}
P(OPh) ₃	6.56	PPh ₃	3.96
PBu ₃	4.74	PCy ₃	2.27

^a From ref 110.

A kinetic and equilibrium study¹¹¹ of carbamoyl complex formation (eq 8) from Mn and Re carbonyls showed that the rate

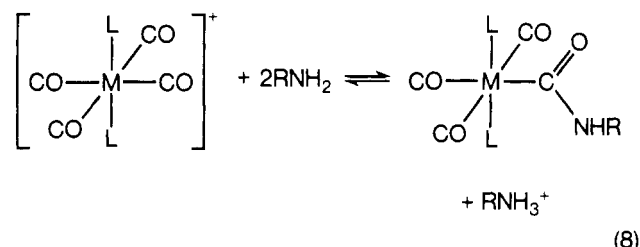

decreases in the order: PMePh₂ > PMe₂Ph > PPh₃. The order of the first two is expected from electronic factors but the rate with PPh₃ is abnormally slow, suggesting steric inhibition of the associative reaction. The rate also decreases with increasing bulk of the amine in the order R = *sec*-Bu > *i*-Pr > Cy > *t*-Bu, and decreasing the size of the metal from Re to Mn. Equilibrium constants decrease with increasing bulk of phosphine or amine.

Rates of reaction of KH with HCoL₄ complexes decrease in the order P(OMe)₃ > P(OEt)₃ > P(OPh)₃.⁸⁷

E. Ligand Exchange Equilibria

There are many situations where ligands compete for coordination sites on a transition metal. It was a study² of competition equilibria among phosphorus ligands for Ni(0) which first led me to realize the importance of steric effects. Ligand exchange in eq 9 shows a bonding order L' = P(OMe)₂Ph > PMe₂Ph ~ P(OEt)₃ > PEt₃ > PEt₂Ph ~ PPr₂Ph ~ PBu₂Ph > AsMe₂Ph > AsEt₂Ph.¹¹²

TABLE XXXVIII. Equilibrium Constants^a in Hexane for the Reaction:
$$cis\text{-Mo}(\text{CO})_4(\text{PPh}_3)(\text{NHC}_5\text{H}_{10}) + \text{L} \rightleftharpoons cis\text{-Mo}(\text{CO})_4(\text{PPh}_3)\text{L} + \text{NHC}_5\text{H}_{10}$$

L	K	T, °C
PPh ₃	~30	25
AsPh ₃	1.9	36.5
P(<i>o</i> -Tol) ₃	<0.09	25

^a C. L. Hyde and D. J. Darensbourg, *Inorg. Chem.*, **12**, 1286 (1973).

$$\begin{array}{c} \text{CO} \\ | \\ \text{H}-\text{Ru}-\text{L} \\ | \quad | \\ \text{L} \quad \text{Cl} \end{array} + \text{L}' \rightleftharpoons \begin{array}{c} \text{CO} \\ | \\ \text{H}-\text{Ru}-\text{L}' \\ | \quad | \\ \text{L} \quad \text{Cl} \end{array} + \text{L} \quad (9)$$

L = PEt₂Ph, PPr₂Ph, or PBu₂Ph

With the exception of P(OEt)₃, the order of the phosphorus ligands is that of increasing θ . The PPh₃ in (*o*-Tol)NiBr(PPh₃)₂ is quantitatively replaced by PMePh₂, which in turn is replaced by PMe₂Ph.¹¹³ Larger phosphines, P(*o*-Tol)₃ and P(*o*-C₆H₄OCH₃)₃ do not react. P(*i*-Pr)₃ and PCy₃ in Cr(CO)₄C(OMe)MeL are displaced by PEt₃ or PBu₃.¹¹⁴ A greater degree of substitution occurs when P(OMe)₃ reacts with H₂Fe(PMePh₂)₄ than when it reacts with H₂Fe[P(OEt)₃]₄.¹¹⁵

The length of the methylene chain in chelating diphosphines markedly affects their coordinating ability. ³¹P studies¹¹⁶ of competition for coordination to Ni(0) show decreasing bonding ability in the order Ph₂P(CH₂)₃PPh₂ ~ Ph₂P(CH₂)₂PPh₂ > Ph₂P(CH₂)₄PPh₂ >> Ph₂PCH₂PPh₂. The last may have an inadequate bite.

Competition of phosphorus ligands with ligands of other types is also strongly influenced by the size of L. One of the best studied other ligands is CO. Figure 9 showed the results for Ni(0). Reimann and Singleton¹¹⁷ have studied the reactions of ReBr(CO)₅ with 15 different phosphorus ligands and have found that rates and equilibria of CO substitution are controlled by the size of L. For example, PEt₃ and PEtPh₂ give equilibrium mixtures of ReBr(CO)₃L₂ and ReBr(CO)₂L₃, while PPh₃ gives only disubstitution. MnBr(CO)₅ behaves similarly except that trisubstitution is even more difficult on the smaller metal. MnBr(CO)₅L₄ can be made with the very small ligand P(OMe)₃.¹¹⁸

Complexes of weakly held ligands can be favored by increasing the size of the phosphines. Thus Ni(PEt₃)₄ forms an N₂ complex [(N₂)Ni(PEt₃)₃] in solutions under nitrogen,¹¹⁹ because a phosphine dissociates readily to form a coordinatively unsaturated 16-electron complex. Ni(PMe₃)₄ shows no tendency to dissociate an L or to coordinate N₂. An N₂ complex forms in the cyclohexylphosphine-nickel system, but the Ni is three-coordinate in an N₂ bridged dimer: N₂[Ni(PCy₃)₂]₂.¹²⁰

Electronic factors are also involved in the formation of N₂ complexes, which require a metal with very good back-bonding ability. Thus Pd(PEt₃)₃ and Pt(PEt₃)₃ do not form a detectable amount of N₂ complex at 50 psig, nor does Ni[P(*o*-Tol)₃]₃.¹¹⁹

Nitriles do coordinate to Ni(0) complexes containing phosphines.¹²¹ The equilibrium constant for eq 10 with L = P(*o*-Tol)₃ is ~10 at 25 °C. With L = P(*o*-*p*-Tol)₃, K is too small to be readily measured (~10⁻⁷). [These values were estimated from the equilibrium constants¹²¹ for CH₃CN + Ni[P(*o*-Tol)₃]₃ ⇌ (CH₃CN)Ni[P(*o*-Tol)₃]₃ at various temperatures and the known NiL₄ dissociation constants.⁹]

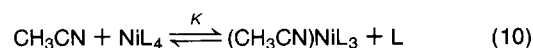

Equilibrium 11 lies far to the left for R = H, but far to the right for R = Me, *i*-Pr, or Ph.¹²² The HCoL₄ complexes can be prepared from the two smaller phosphites but not the larger ones.

TABLE XXXIX. Equilibrium Constants^a in Toluene at 35.4 °C for the Reaction:
$$\text{W}(\text{CO})_5(\text{NH}_2\text{Ph}) + \text{L} \rightleftharpoons \text{W}(\text{CO})_5\text{L} + \text{NH}_2\text{Ph}$$

L	K	L	K
PBu ₃	225	PPh ₃	17.1
P(OCH ₂) ₃ CET	180-360	AsPh ₃	11.2
PCy ₃	198	SbPh ₃	7.5
P(SCH ₂) ₃ CMe	45.3	P(OPh) ₃	6.6
P(OBu) ₃	31.2	BiPh ₃	1.1

^a R. J. Angelici and C. M. Ingemanson, *Inorg. Chem.*, **8**, 83 (1969).

TABLE XL. Percentage of Ionic Product^a in Acetone at Room Temperature for the Reaction:
$$\text{C}_7\text{H}_8\text{RhCl} + \text{L} \rightleftharpoons \text{C}_7\text{H}_8\text{RhL}_2^+ + \text{Cl}^-$$

L	% ionic product
PMe ₂ Ph	15
PMePh ₂	1
PPh ₃	0
PPhCy ₂	0

^a R. R. Schrock and J. A. Osborn, *J. Am. Chem. Soc.*, **93**, 2397 (1971).

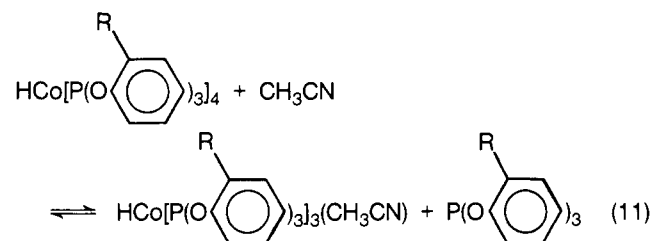

Olefins compete more effectively with smaller ligands. K's for eq 12 are about 10⁴ for L = P(*o*-Tol)₃ and 10⁻⁴ for L = P(*o*-*p*-Tol)₃.¹²³ [An x-ray crystal structure¹²⁴ of (CH₂=CHCN)-Ni[P(*o*-Tol)₃]₂ shows that the acrylonitrile is indeed coordinated by its double bond.] The similarity of this 10⁸ factor to the ratio of NiL₄ dissociation equilibrium constants (Table II) indicates that the strain energy in Ni[P(*o*-Tol)₃]₄ is completely relieved when the first P(*o*-Tol)₃ is removed; removal of the second ligand from NiL₃ requires essentially the same energy for L = P(*o*-Tol)₃ as for L = P(*o*-*p*-Tol)₃.

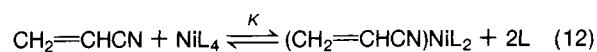

It is understandable that all known (C₂H₄)NiL₂ complexes have L's with $\theta \gtrsim 130^\circ$. The strength of a Ni-ethylene bond is only slightly stronger than a Ni-P,¹²⁵ so smaller L's preferentially form NiL₄ complexes.

Competitions of group 5 donor ligands with piperidine and aniline are shown in Tables XXXVIII and XXXIX.

Though the K's in Table XXXIX generally decrease as the phosphorus ligand becomes more electronegative, the small P(OCH₂)₃CET does better and the large PCy₃ worse than expected on the basis of electronic effects alone. Note the order PPh₃ > AsPh₃ > SbPh₃ > BiPh₃. Recently Nasielski and co-workers¹²⁶ have pointed out that the K's are not based on true thermodynamic concentrations but rather on pseudostationary states in a photochemical reaction.

Data on competition of chloride ions with phosphines are given in Table XL (C₇H₈ = norbornadiene). The percentage of ionic product was determined by conductivity measurements.

F. Oxidative Addition Reactions

Oxidative addition in the broadest sense includes all those reactions where one or two odd-electron fragments (usually the

TABLE XLI. Equilibrium and Rate Constants^a in Acetone at 25 °C under Air at 1 Atm for the Reactions:

$$\text{Co}(\text{acacen})\text{NO} + \text{L} \xrightleftharpoons{K} \text{LCo}(\text{acacen})\text{NO}$$

$$\text{LCo}(\text{acacen})\text{NO} + \frac{1}{2}\text{O}_2 \xrightarrow{k} \text{LCo}(\text{acacen})\text{NO}_2$$

L	K, M ⁻¹	10 ² k × [O ₂], s ⁻¹
PMe ₂ Ph	37	11.1
PEt ₃	23	6.67
PBu ₃	19	6.67
PEtPh ₂	5.4	5.75
P(OBu) ₃	1.87	0.8
P(OPh) ₃	No oxidation observed	
PPh ₃	No oxidation observed	
PCy ₃	No oxidation observed	

^a From ref 130.**TABLE XLII. Rate Constants^a in Benzene at 25 °C for the Reaction:**

$$\text{IrCl}(\text{CO})\text{L}_2 + \text{PhCH}_2\text{Cl} \xrightarrow{k} \text{PhCH}_2\text{IrCl}_2(\text{CO})\text{L}_2$$

L	k, M ⁻¹ s ⁻¹
PEtPh ₂	1.5 × 10 ⁻³
PEt ₂ Ph	5.5 × 10 ⁻⁴
P(<i>p</i> -C ₆ H ₄ OCH ₃)	3.3 × 10 ⁻⁴
PPh ₃	1.2 × 10 ⁻⁴
P(<i>p</i> -C ₆ H ₄ Cl)	2.0 × 10 ⁻⁵

^a From ref 131.

latter, formed by cleavage of a bond in X–Y) are added to a transition metal, with an attendant increase in its formal oxidation state.¹²⁷ We can anticipate steric inhibition in direct associative reactions, and steric acceleration if prior dissociation of L or other ligand from an 18-electron complex is required as a first step.¹²⁸

Data of Halpern and Phelan¹²⁹ for the associative reaction of benzyl bromide with Co(DH)₂L are shown in Figure 24. Larger L's inhibit the reaction. There is also an electronic effect: electron-withdrawing P(*p*-C₆H₄Cl)₃ is slower than P(*p*-C₆H₄OCH₃)₃, and P(OMe)₃ falls below the line defined by the phosphines.

Rates of oxidation of Co(acacen)NO (41) with air depend on the concentration of added L, reaching a limiting value at high

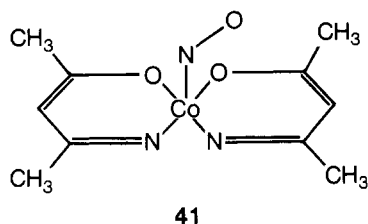
**TABLE XLIII. Rate and Equilibrium Constants^a in Chlorobenzene at 30 °C for the Reaction: XY + *trans*-IrCl(CO)L₂ ⇌ (XY)IrCl(CO)L₂**

L	XY = H ₂		XY = O ₂		XY = HCl
	k, s ⁻¹ M ⁻¹	10 ⁻³ K, M ⁻¹	10 ² k, s ⁻¹ M ⁻¹	10 ⁻³ K, M ⁻¹	k, s ⁻¹ M ⁻¹ ^b
PPh ₃	1.2	31	5.9	28	1.1 × 10 ⁴
P(<i>p</i> -Tol) ₃	1.7	44	9.6	21	2.4 × 10 ⁴
P(<i>m</i> -Tol) ₃	0.69	25	4.4	7.0	2.7 × 10 ³
PCy ₃	0.0066	2.4	0.038	0.066	≤ 4.0
P(<i>o</i> -Tol) ₃	No reaction in 3 h at 740 mm		No reaction in 18 days at 700 mm		0.79

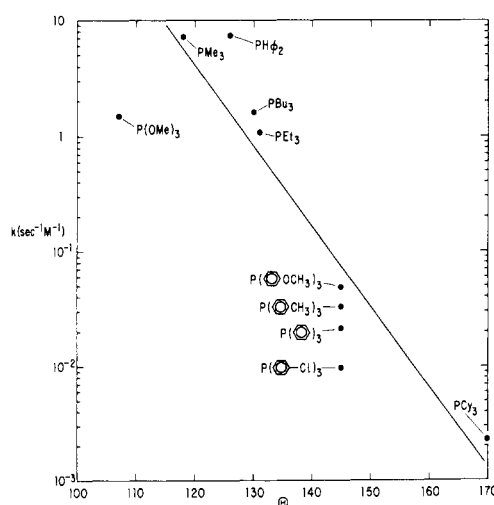
^a From ref 132. ^b Data in benzene.**Figure 24.** Rate constants in benzene at 25 °C for the reaction 2Co(DH)₂L + PhCH₂Br → PhCH₂Co(DH)₂L + BrCo(DH)₂L, from ref 129.

[L].¹³⁰ Both a preassociation equilibrium constant and a rate constant (Table XLI) could be determined by analyzing the data. The ineffectiveness of PCy₃ in promoting the oxidation was attributed to its low coordinating ability. Larger size hurts both K and k, especially the former.

Ugo and co-workers¹³¹ examined electronic and steric effects of L in oxidative addition reactions of IrCl(CO)L₂ complexes. Selected data are shown in Table XLII. While the effect of electron-withdrawing substituents in slowing the rate is clear, the steric effects are not obvious. Unfortunately the study was restricted to a very narrow range of ligand size (136–145°). Vaska and co-workers¹³² have recently reported results of rate and equilibrium studies which include L = PCy₃ and P(*o*-Tol)₃ (Table XLIII). Both k and K are hurt by making L very large. P(*m*-Tol)₃ acts slightly larger than P(*p*-Tol)₃. Note that the decrease in K on going from P(*m*-Tol)₃ to PCy₃ is larger for O₂ than for H₂, presumably reflecting the greater steric requirements of O₂ in the product.

While eq 13 proceeds at 0 °C when L = PMe₃, no reaction occurs when L = PEt₃.¹³³



IrCl(CO)[PMe₂(*t*-Bu)]₂ undergoes rapid oxidative addition with a variety of small molecules. IrCl(CO)[PEt₂(*t*-Bu)]₂ reacts much less readily, but will react with Cl₂ and O₂. IrCl(CO)[PMe(*t*-Bu)]₂ reacts only very slowly with Cl₂ and O₂ and IrCl(CO)[PEt(*t*-Bu)]₂ does not react at all.¹³⁴

A remarkable case of steric inhibition of oxidative addition has been reported by Otsuka and co-workers.⁶⁵ Pd[PPh(*t*-Bu)]₂ reacts readily with O₂ to form an O₂PdL₂ complex, as expected for this highly coordinatively unsaturated complex. The still more crowded Pd[P(*t*-Bu)]₂ is stable in air! Apparently there is not room even for a relatively small O₂ molecule.

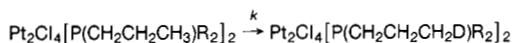
TABLE XLIV. Rate Constants^a in CH₃COOD/D₂O/CDCl₃ (5/1/5) at 100 °C for the Reaction:

L	10 ⁴ k _{obsd} , s ⁻¹	L	10 ⁴ k _{obsd} , s ⁻¹
PPr ₃	1.8	PPr ₂ -t-Bu	4.3
PPr ₂ Ph	1.9	PPr(t-Bu) ₂	48
PPrPh ₂	2.0		

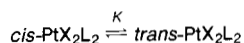
^a from ref 138.**TABLE XLV.** Equilibrium Constants^a in Benzene at 25 °C for the Reaction:

L	X = Cl	X = I
PEt ₃	12.3	
ppr ₃	29.5	~180
PBu ₃	25.5	
P(pentyl) ₃	28.4	
AsMe ₂ Et	55	
AsEt ₃	175	
AsPr ₃	~650	
AsBu ₃	~340	
AsBu ₂ Ph	9.6	
SbEt ₃	1.9	~90
SbPr ₃	4.0	
SbBu ₃	3.75	

^a From ref 142.

trans-RhCl(CO)[PMe₂(*o*-C₆H₄OCH₃)]₂ undergoes oxidative addition with a variety of small molecules such as HCl, MeI, CCl₄, and Cl₂. The more crowded *trans*-RhCl(CO)[P(*t*-Bu)₂(*o*-C₆H₄OCH₃)]₂ does not react with them but rather demethylates with loss of the elements of CH₃ and Cl.¹³⁵

Rates of ortho-metalation reactions of CH₃Mn(CO)₄L complexes increase with the size of L in the sequence PMe₂Ph (no reaction) < P(Ph)₃ < PPh₃ < P(*o*-Tol)₃.¹³⁶ Steric acceleration of intramolecular oxidative addition reactions is now firmly established, especially by the extensive work of Shaw and co-workers.¹³⁷ Two factors are probably involved: (1) more ready dissociation of other ligands to give coordinative unsaturation, and (2) a close proximity to the metal of the bond to be broken as a consequence of steric crowding.

A study by Masters and co-workers¹³⁸ shows the effect of steric crowding on the rate of H-D exchange on C-3 of the propyl group in Pt₂Cl₄(PPR₂)₂ complexes (Table XLIV).

Increasing the bulk of the ligand also stabilizes four-membered ring intermediates, as shown by an increase in the rate of exchange at C-2 relative to C-3.¹³⁸

An example of the effect of structural constraints on an oxidative addition reaction is the decreasing equilibrium constants (a factor of >30) for eq 14 in the sequence L = P(OEt)₃ < PO-Me(OCH₂)₂CMe₂ < P(OCH₂)₃CR.⁶⁸

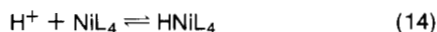

In this case, of course, the constraint reduces the electron density on nickel. A greater Ni 2p_{3/2} binding energy (0.5 eV) for Ni[P(OCH₂)₃CMe]₄ than for Ni[P(OEt)₃]₄ is observed by ESCA.¹³⁹

The chain length in Ph₂P(CH₂)_nPPh₂ complexes can have a marked effect on reactivity. For example, Ni[Ph₂P(CH₂)₄PPh₂]₂ reacts with PhBr at 50 °C to give PhNiBr[Ph₂P(CH₂)₄PPh₂]₂ while Ni[Ph₂P(CH₂)₃PPh₂]₂ does not react under these conditions.¹⁴⁰ With the more reactive PhCOBr, both complexes react at 70 °C but give different products. PhCONiBr[Ph₂P(CH₂)₃PPh₂]₂ is stable for at least 40 h, but the more crowded PhCONiBr[Ph₂P-

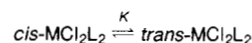
TABLE XLVI. Equilibrium Constants^a in Benzene at 25 °C for the Reaction:

L	M = Pd	M = Pt
SbMe ₃	1.5	0.25
SbEt ₃	15.7	1.9
SbPr ₃	25.3	4.0
SbBu ₃	26.0	3.8
SbPh ₃	5.8	

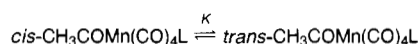
^a J. Chatt and R. G. Wilkins, *J. Chem. Soc.*, 70 (1953).**TABLE XLVII.** Equilibrium Constants^a in Benzene at 25 °C for the Reaction:

L	K	L	K
P(OCH ₂) ₃ CMe	~0 ^b	SbPh ₃	~0 ^b
P(OMe) ₃	0.11	AsPh ₃	0.11
PMe ₂ Ph	~0	PPh ₃	0.42
PEt ₃	~0		

^a C. S. Kraihanzel and P. K. Maples, *Inorg. Chem.*, 7, 1806 (1968). ^b Too little of the trans isomer to detect.

(CH₂)₄PPh₂] reacts with excess PhCOBr to give a mixture of NiBr₂[Ph₂P(CH₂)₄PPh₂]₂, Ni(CO)[Ph₂P(CH₂)₄PPh₂]₂, and PhCOPh.

Ni[Ph₂P(CH₂)₄PPh₂]₂ reacts readily with HCN in a 1:1 ratio to give HNiCN[Ph₂P(CH₂)₄PPh₂]₂ (one diphosphine monodentate).⁹⁰ Ni[Ph₂P(CH₂)₂PPh₂]₂ and Ni[Ph₂P(CH₂)₃PPh₂]₂ under the same conditions react to only a small extent.¹⁴¹

G. Isomerism

1. Cis-Trans

The most familiar cis-trans isomerism is in MX₂L₂ complexes of Pd and Pt. Table XLV shows some data published several years ago by Chatt and Wilkins¹⁴² which show that the trans/cis ratio is generally favored by bulkier L and by iodide over chloride. The stabilizing effect of the phenyl group on *cis*-PtCl₂(AsBu₂Ph)₂ was said to be partly electronic. An earlier study of stilbene complexes by the same authors (Table XLVI) showed a marked increase in K when Me was replaced by Et, and smaller changes on going to Pr or Bu. SbPh₃ gave more *cis*-PdCl₂(SbPh₃)₂ than expected on the basis of size alone. The less crowded complexes gave a higher percentage of cis isomers.

Recent studies by Verstuyft and Nelson¹⁴³ on PdX₂L₂ complexes [L = PMe₂-*p*-C₆H₄Y or PMe(*p*-C₆H₄Y)₂] show that the trans/cis ratio is favored by (1) making L bulkier, (2) changing X⁻ from N₃⁻ to Cl⁻ to I⁻, (3) making Y more electronegative, and (4) going to less polar solvents. Unfortunately the range of θ is very limited.

MX₂[P(*o*-Tol)₃]₂ complexes tend to favor the trans isomer on going from P(*o*-*p*-Tol)₃ or P(*o*-*m*-Tol)₃ to P(*o*-*o*-Tol)₃, from Cl or Br to I, and from Pt to Pd.¹⁴⁴

The rates of cis-trans equilibration in MX₂L₂ complexes also depend on the size of L. The much slower rate of PdCl₂[PMe₂(*o*-Tol)]₂ compared to PdCl₂[PMe₂Ph]₂ has been attributed to steric interference of a rate-determining associative reaction.¹⁴⁵ Catalysis by added phosphines is a general feature of these reactions. A decreasing efficiency in the order PMe₂Ph ~ PBu₃ > PMe₂(*o*-Tol) >> PMe(*o*-Tol)₂ > PPh₃ indicates that smaller ligands are better isomerization catalysts.

Selected trans/cis isomer ratios in CH₃COMn(CO)₄L complexes are shown in Table XLVII. P(OMe)₃ has a greater tendency to go trans to the relatively bulky acyl than would be expected

TABLE XLVIII. Equilibrium Constants^a in Toluene-*d*₈ at 60 °C for the Reaction:
$$cis\text{-}(\text{carbene})\text{M}(\text{CO})_4\text{L} \xrightleftharpoons{K} trans\text{-}(\text{carbene})\text{M}(\text{CO})_4\text{L}$$

Carbene	L	K
M = Cr		
Me(OMe)C:	PMe ₃	0.34
	PEt ₃	0.52
	PBu ₃	0.54
	P(octyl) ₃	0.56
	P(<i>i</i> -Pr) ₃	1.69
	PCy ₃	1.82
	P(<i>p</i> -Tol) ₃	0.19
	PPh ₃	0.22
Me(OEt)C:	P(<i>p</i> -C ₆ H ₄ F) ₃	0.31
	PBu ₃	0.50
Et(OMe)C:	PBu ₃	0.87
Ph(OMe)C:	PBu ₃	0.94
<i>i</i> -Pr(OMe)C:	PBu ₃	2.22
M = W		
Me(OMe)C:	PBu ₃	0.09
Ph(OMe)C:	PBu ₃	0.24

^a H. Fischer and E. O. Fischer, *Chem. Ber.*, **107**, 673 (1974).

on the basis of size alone. Reaction of *cis*-CH₃COMn(CO)₄L complexes with L gave only **42** at equilibrium when L = P(OCH₂)₃CMe or PHPh₂, a mixture of **42** and **43** when L = P(OMe)₃, and only **43** for the largest ligands PMe₂Ph, P(OPh)₃, PEt₃, or PMePh₂.¹⁴⁶ PPh₃ would not give a CH₃COMn(CO)₃L₂ complex.

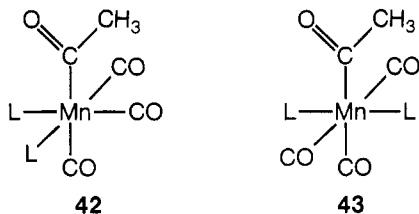

Equilibrium 15 shifts toward **45** in the sequence R = R' = H < R = H, R' = CH₃ < R = R' = CH₃. With Ph₂PCH(CH₃)PPh₂, the only isomer observed is **46**. If the CH₃CO is replaced by the smaller CH₃, only the fac isomer analogous to **44** is seen even if R = R' = CH₃.¹⁴⁷

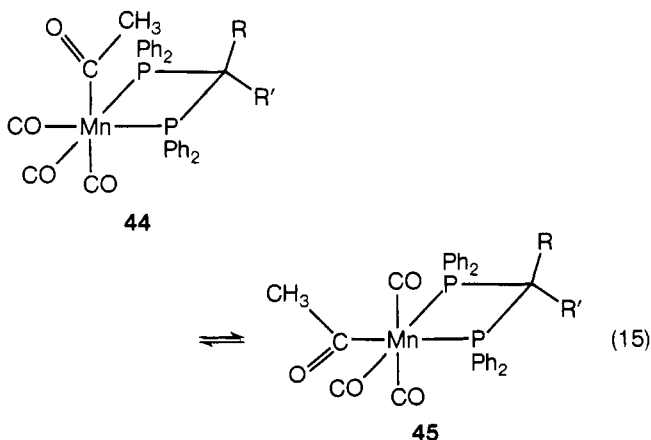

Trans/cis ratios in (carbene)M(CO)₄L complexes are larger for larger L, larger carbene, and smaller M (Table XLVIII). The aryl phosphine results are anomalous relative to the alkyl phosphines but do indicate a greater trans/cis ratio for more electronegative L.

Both electronic and steric factors are involved in the equi-

TABLE XLIX. Equilibrium Constants^a in CDCl₃ at 25 °C for the Reaction:

L	R = Cl	Br	I	H	Me	Bz
P(OPh) ₃	<0.02		<0.02	0.03	1.7	5.6
SbPh ₃			0.04			
PBu ₃	<0.02		0.13	0.48	7.1	
PMe ₂ Ph			0.36	0.93 ^b		
PPh ₃	<0.02	0.04	1.16	0.59 ^b	12.5 ^c	>50
P(OMe) ₃	0.11	0.34	3.3	0.19	5.9	

^a J. W. Faller and A. S. Anderson, *J. Am. Chem. Soc.*, **92**, 5852 (1970). ^b In *o*-dichlorobenzene. ^c In toluene.

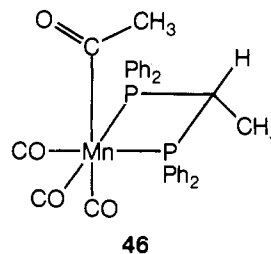

librium in Table XLIX. *K* does increase regularly in the sequences Cl < Br < I and H < Me < Bz.

While Rh(CO)₂L₃⁺ complexes have configuration **47** in solution (two carbonyl bands in the IR) when L = PMePh₂ or AsMePh₂, they have **48** when L = P(*p*-Tol)₃, PPh₃, AsPrPh₂, or AsPh₃.¹⁴⁸ Attempts to prepare a tris phosphine complex with P(*o*-Tol)₃ failed, giving only **49**.

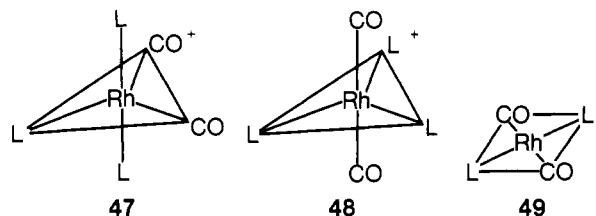

The isomer distribution in eq 16 (L = PR₃, AsR₃, or SbR₃) depends on both steric and electronic effects.¹⁴⁹ Equilibria shift to the right in the series R = Me < Et ~ Pr ~ Bu < *n*-pentyl < *n*-octyl < isopentyl < *i*-Bu < *sec*-alkyl, SbR₃ < AsR₃ < PR₃, and X = CF₃ < Br < F ~ H < Me < OMe when L = AsEt₂(*p*-C₆H₄X).

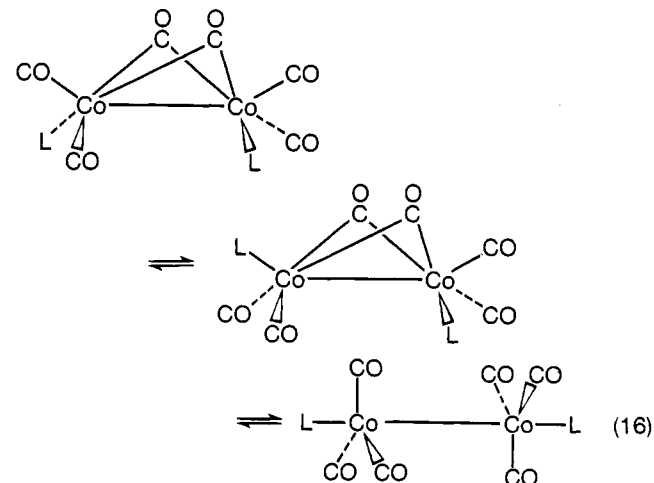
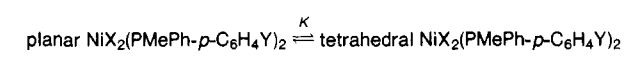

TABLE L. $\text{NiX}_2(\text{PRPh}_2)_2$ isomers isolated^a

R	X = Cl	Br	I
Me	P	T	T
Et	P	P,T	T
Pr	P	P,T	T
Bu	P,T	P,T	T
<i>n</i> -Amyl	P,T	T	T
<i>t</i> -Bu	P	P,T	T
<i>i</i> -Pr	P	P,T	T,G
<i>sec</i> -Bu	P	P,T	T,G
<i>t</i> -Bu		T	T

^a From ref 151. Abbreviations: P, planar; T, tetrahedral; G, a green isomer of unknown structure.

TABLE LI. Equilibrium Constants^a in CDCl_3 at 25 °C for the Reaction:

Y	X = Cl	Br	I
CF ₃	0.15		0.56
Cl	0.23	0.75	1.22
H	0.41	1.43	2.70
Me	0.45	2.12	3.00
OMe	0.56	2.33	
NMe ₂	1.00	4.88	11.5

^a L. H. Pignolet, W. D. Horrocks, Jr., and R. H. Holm, *J. Am. Chem. Soc.*, **92**, 1855 (1970).

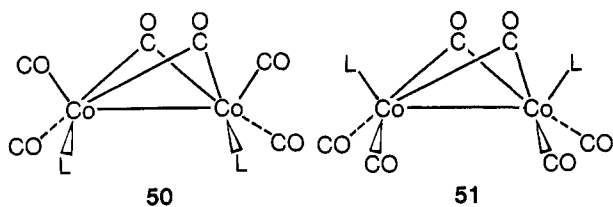

2. Square-Planar/Tetrahedral

While PtX_2L_2 and PdX_2L_2 complexes usually form both *cis* and *trans* complexes, the planar complexes of the smaller cation Ni(II) are invariably *trans*; for certain X and L there can be an appreciable fraction of a paramagnetic tetrahedral isomer. For small R (e.g., Me or Et), $\text{NiX}_2(\text{PR}_3)_2$ and $\text{NiX}_2(\text{PR}_2\text{Ar})_2$ complexes are *trans* square planar and diamagnetic in the solid state and in solution. $\text{NiX}_2(\text{PRAr}_2)_2$ complexes give a measurable amount of both isomers in solution while $\text{NiX}_2(\text{PAR}_3)_2$ are essentially 100% tetrahedral in both solution and solid states.¹⁵⁰

In the $\text{NiX}_2(\text{PRPh}_2)_2$ series, Hayter and Humiec¹⁵¹ were able to isolate the crystalline isomers shown in Table L. Both planar and tetrahedral isomers are present in the crystalline unit cell of $\text{NiBr}_2(\text{PPh}_2\text{Bz})_2$.¹⁵²

The tendency to favor the tetrahedral form in the sequence $\text{X} = \text{Cl} < \text{Br} < \text{I}$ is shown in the solid state in Table L and in solution in Table LI. The latter clearly shows the importance of electronic effects in the phosphine on *K*. The tetrahedral isomer is favored by electron-donating L. This is in accord with our observation, based on ESCA measurements,¹³⁹ that the Ni(II) in a tetrahedral isomer is more electron deficient than in the corresponding planar one. It cannot, however, explain the increase in *K* in the sequence $\text{PR}_3 < \text{PR}_2\text{Ph} < \text{PPh}_3$, which must therefore be determined primarily by steric effects.

Some results of a study by Que and Pignolet¹⁵³ are shown in Table LII. They concluded that steric effects are relatively unimportant. Their conclusion is, however, based on the questionable assumption that steric effects must be *monotonic* with increasing Θ .

Consider a *trans*- NiX_2L_2 complex **52** with small L. Increasing the size of L (or X) will cause a repulsive interaction between

TABLE LII. Equilibrium Constants^a in CH_2Cl_2 at 31 °C for the Reaction:
$$\text{planar NiBr}_2\text{L}_2 \xrightleftharpoons{K} \text{tetrahedral NiBr}_2\text{L}_2$$

L	Θ	K	Ref
PMePh ₂	136	1.78	153
PEtPh ₂	140	2.03	155
PPrPh ₂	140	2.33	155
PPh ₃	145	<i>b</i>	153
PPh ₂ Cy	153	2.45	153
PPhCy ₂	161	0.14	153
PCy ₃	170	0.00	153

^a From ref 153. ^b Very large.

L and X which can be relieved by a tetrahedral distortion toward **53**, where the LNiX angles are opened from 90 to 109.5° (and

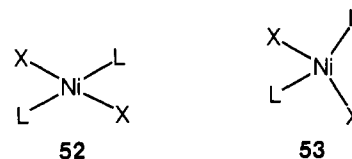

the LNiL angle is decreased from 180 to 109.5°). Still larger increases in Θ will lead to a severe repulsive interaction of L with L, favoring an opening of the LNiL angle back toward **52**. The value of Θ for optimum stability of the tetrahedral form must be around 145°; PCy₃ is too large. A square-planar geometry for $\text{NiCl}_2(\text{PCy}_3)_2$ has been established by an x-ray study.¹⁵⁴

LaMar and Sherman¹⁵⁵ reported a second-order acceleration of the planar-tetrahedral interconversion for $\text{NiBr}_2(\text{PMePh}_3)_2$ with added phosphine, along with exchange of free and coordinated phosphine. PPh₃ exchanges more slowly with $\text{NiBr}_2(\text{PPh}_3)_2$. The still bulkier PPh₂Cy does not exchange with $\text{NiBr}_2(\text{PPh}_2\text{Cy})_2$ and its addition has no effect on the interconversion rate.¹⁵³

A steric effect is clearly shown in the planar-tetrahedral equilibrium of $\text{NiX}_2[\text{Ph}_2\text{P}(\text{CH}_2)_n\text{PPh}_2]$ complexes. Increasing *n* from 2 to 3 for X = Cl increases *K* from ~0 to 0.75 in CH_2Cl_2 at 22 °C.¹⁵⁶ An earlier study on the Br and I complexes gave a similar result.¹⁵⁷ Attempts to make $\text{NiX}_2(\text{Ph}_2\text{PCH}_2\text{PPh}_2)$ complexes failed; the complexes isolated contained two monodentate diphosphines.

3. Ambidentate

Unsymmetrical diphosphines are capable of preferential bonding at one end. Reaction of $\text{Ph}_2\text{PCH}_2\text{CH}_2\text{PMePh}$ with $(\text{C}_6\text{H}_5\text{NH}_2)\text{W}(\text{CO})_5$ in a 1:1 ratio gave predominantly (90%) the isomer with the -PMePh end coordinated. Reaction of $\text{Ph}_2\text{PCH}_2\text{CH}_2\text{PPh}(\text{i-Pr})$ gave predominantly (85%) the PPh₂ bound isomer.¹⁵⁸ The smaller end of the diphosphine is preferred in each case.

Reaction of $\text{P}(\text{OCH}_2)_3\text{P}$ with $(\text{C}_6\text{H}_5\text{NH}_2)\text{W}(\text{CO})_5$ in a 1:1 ratio at room temperature [or with $\text{Cr}(\text{CO})_6$ or $\text{Mo}(\text{CO})_6$ under UV radiation] gave predominantly the isomer with the smaller PO₃ end coordinated.¹⁵⁹ It was possible, however, to isolate both isomers by irradiation of $\text{Fe}(\text{CO})_5$,¹³ where the crowding is presumably less.

Changing the size of phosphorus ligands on a metal can affect the coordination of other ambidentate ligands, as we saw for SCN in Figure 12. Carty and co-workers¹⁶⁰ have concluded that steric effects also dominate the bonding mode in *trans*- $\text{Pd}(\text{SCN})_2\text{L}_2$ complexes. The crystal structures show S bonding with L = P(OPh)₃ but N bonding with the larger PPh₃.

4. Other

An extremely important problem in many homogeneous catalytic reactions is how to control the formation of primary and

TABLE LIII. Structural Preference of $[\text{CuXL}]_4$ Complexes^a

	L = PEt ₃	PPh ₃
X = Cl	56	56
Br	56	57
I	56	57

^a From ref 163.

secondary alkyl products. Frequently the distribution depends on equilibria in solution. Bennett and Charles¹⁶¹ found that reactions of secondary (R²) acyl chlorides with IrCl(PPh₃)₃ (eq 17)

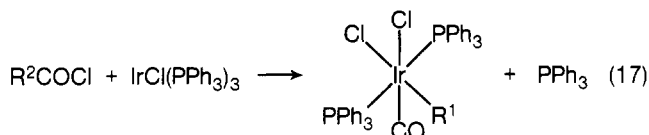

always led to isolation of primary (R¹) alkyl products. Using models, they concluded that the instability of the intermediate secondary alkyl complexes is due to unfavorable steric interactions of the alkyl group with the triphenylphosphines.

Though they did not look at complexes with smaller phosphines, they did investigate the reactions of acyl chlorides with $[\text{IrCl}(\text{CO})(\text{cyclooctene})_2]_2$ to give **54**.¹⁶¹ In this less crowded

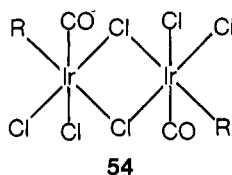

structure, 2-methylpropanoyl chloride gave the R = *i*-Pr complex. An equilibrium mixture containing ~50% *i*-Pr and ~50% *n*-Pr could be obtained by refluxing 90 min in benzene. The equilibrium between butyl isomers favors R = *n*-Bu.

Otsuka and co-workers¹⁶² prepared complexes **55** in order to resolve racemic tertiary phosphines such as PPh(α -naphthyl)(*p*-C₆H₄OEt). When PPh(α -naphthyl)(*o*-Tol) was used, isomers attributed to restricted rotation of the *o*-tolyl group were obtained which did not interconvert up to 80 °C.

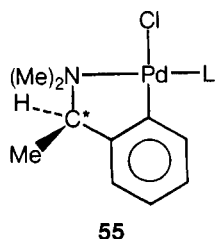

$(\text{CuXL})_4$ has a cubane structure **56** for small X and L but goes over to a step structure **57** as they become larger (Table LIII).¹⁶³

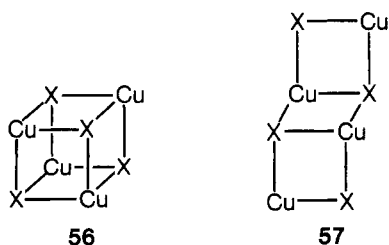

Equilibrium 18 depends on R' and R.¹⁶⁴ It is completely to the left with R' = *t*-Bu (R = H, Me, Cl). For R' = Me, it shifts to the right (Table LIV) as the size of R increases. Equilibrium 19 is completely to the left for R' = H, Me or *t*-Bu.¹⁶⁴ (Both R' and PR₂ can take the less crowded equatorial positions). ³¹P Chemical shifts (Table LV) depend on the isomer and show an effect on

TABLE LIV. Equilibrium Constants^a at 27 °C for the Reaction:
$$58 \rightleftharpoons 59$$

R	K
H	0.81
Me	0.89
Cl	1.75

^a From ref 164. R' = MeTABLE LV. ³¹P Chemical Shifts^a in 4-R'(cyclohexyl)PMe₂ Phosphines

R'	Structure	T, K	$\delta(^{31}\text{P})$, ppm
<i>cis</i> - <i>t</i> -Bu	58	300	54.8
<i>cis</i> -Me	58	183	57.2
<i>cis</i> -Me	<i>b</i>	300	49.0
<i>cis</i> -Me	59	183	44.2
H	60	300	42.7
<i>trans</i> -Me	60	300	42.5
<i>trans</i> - <i>t</i> -Bu	60	300	42.5

^a From ref 164. ^b Exchanging between **58** and **59**.

changing R' from Me to *t*-Bu in **58**. 4-*cis*-Me(cyclohexyl)PMe₂ is in rapid exchange between structures **58** and **59** at 300 K and gives an intermediate averaged chemical shift at this temperature.

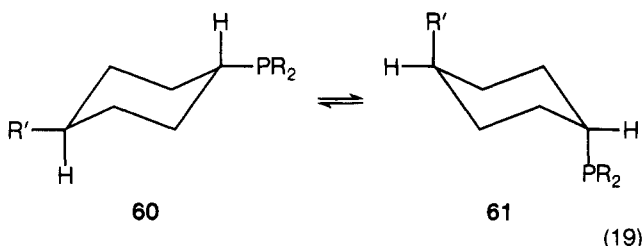
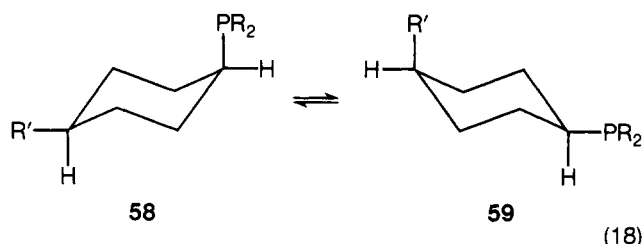

Equilibrium 20 is shifted to the right as R gets larger in the series Me ~ Et < Ph < *i*-Pr < *t*-Bu.¹⁶⁵ Room-temperature ³¹P NMR spectra show exchange averaged chemical shifts.

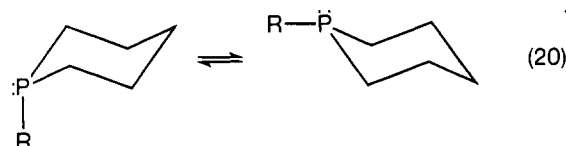

5. Stereochemical Nonrigidity

Intramolecular motions can cause NMR signal averaging and temperature-dependent line shape effects. We saw earlier (Table XVIII) how steric effects can influence rotamer populations and average NMR parameters. This section will deal mainly with steric effects on rates and activation energies.

Barriers (Table LVI) to intramolecular exchange in ML₅ complexes generally increase with the size of L.¹⁶⁶ For fixed L, they tend to be larger for the smaller first-row metals (Table LVII). It has not been possible to prepare ML₅ complexes with P(OPh)₃ ($\theta = 128^\circ$) or larger L.

Barriers in HML₅ complexes decrease with increasing size of L and are smaller for first-row metals (Table LVIII). Both trends

TABLE LVI. Barriers^a to Intramolecular Exchange in RhL₅⁺ Complexes

L	ΔG^\ddagger , kcal/mol	T, K
P(OCH ₂) ₃ CMe	7.8	153
P(OMe) ₃	7.5	200
P(OEt) ₃	9.9	208
P(OCH) ₃ (CH ₂) ₃	10.3	210
P(OBu) ₃	11.1	228

^a From ref 166.TABLE LVII. ΔG^\ddagger (kcal/mol) in M[P(OCH₂)₃CMe]₅ Complexes^a

Co ⁺	10.0	Ni	8.3
Rh ⁺	7.8	Pd	5.7
Ir ⁺	8.4	Pt	7.0

^a P. Meakin and J. P. Jesson, *J. Am. Chem. Soc.*, **96**, 5751 (1974).TABLE LVIII. ΔG^\ddagger (kcal/mol) in HML₅ Complexes^a

HFe(PF ₃) ₄ ⁻	HCo[P(OCH ₂) ₃ CPr] ₄		
	HCo(PF ₃) ₄	5.5	
HRu(PF ₃) ₄ ⁻	HCo[P(OEt) ₃] ₄	<6	HNi[P(OEt) ₃] ₄ ⁺ <5
	HRh[P(OCH ₂) ₃ CPr] ₄	10.5	
	HRh(PF ₃) ₄	9.0	
	HRh[P(OEt) ₃] ₄	7.25	
HOs(PF ₃) ₄ ⁻	Hlr[P(OCH ₂) ₃ CPr] ₄	10.3	
	Hlr(PF ₃) ₄	10.0	

^a P. Meakin, E. L. Muetterties, and J. P. Jesson, *J. Am. Chem. Soc.*, **94**, 5271 (1972), except for the P(OCH₂)₃CPr complexes, by E. M. Hyde, J. R. Swain, J. G. Verkade, and P. Meakin, *J. Chem. Soc., Dalton Trans.*, 1169 (1976).

are consistent with the tetrahedral jump model; the heavy atoms need to move less if they are more nearly tetrahedral.

Rearrangement barriers in H₂ML₄ complexes (M = Fe or Ru) do not change in a systematic way with steric or electronic changes in L.¹⁶⁷ The higher barriers for Ru (for example, 20.1 kcal/mol for H₂Ru(PMe₂Ph)₄ vs. 13.9 for the Fe complex) are, however, consistent with the tetrahedral jump model. The unusual coupling constants observed in the iron complexes [*J*_{PH(cis)} > *J*_{PH(trans)}] were attributed to their greater tetrahedral distortion.¹⁶⁷

Activation energies (in parentheses) for interconverting *cis*- and *trans*-HWCP(CO)₂L decrease as the size of L increases: PMe₃ (15.5 kcal/mol), PEt₃ (14.7), PPh₃ (14.3).¹⁶⁸ On the other hand, the barrier is less for PPh₃ than for PCy₃ in [H₂Os(CO)(NO)L₂]⁺.¹⁶⁹

Rotation of *t*-Bu groups on P can be frozen out at low temperature. Some measured activation energies include W(CO)₅PPh₂(*t*-Bu) (8.3), P(*t*-Bu)₃ (8.6), BH₃P(*t*-Bu)₃ (10.4), and SP(*t*-Bu)₃ (10.5).¹⁷⁰

English and Bushweller have determined the first activation energy for rotation about a metal-phosphorus bond ($\Delta G^\ddagger = 12.6$ kcal/mol at -32 °C) in *trans*-RhCl(CO)P(Cl)(*t*-Bu)₂.¹⁷¹ The low-temperature limit ³¹P{¹H} spectrum shows **62** (~90%), **63**

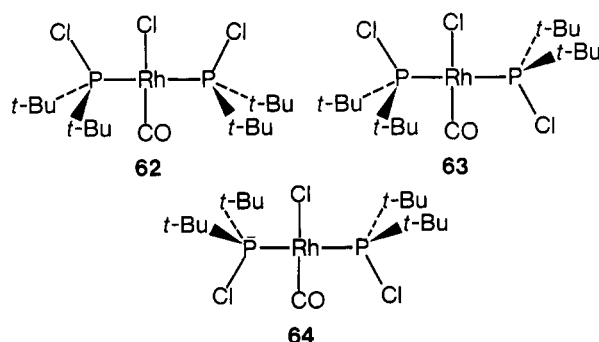

(~10%), and **64** (~1%). The IR spectrum (cyclohexane) shows distinct ν_{CO} bands in decreasing intensity assignable to the three rotamers at 1996, 1975, and 1950 cm⁻¹. The decreasing stability along the series is consistent with the greater size of Cl ($\Theta = 102^\circ$) compared to CO ($\Theta = 92^\circ$).

Mann, Masters, Shaw, and Stainbank¹⁷² had earlier reported freezing out three rotamers of *trans*-RhCl(CO)[PR(*t*-Bu)₂]₂ (R = Me, Et, Pr) in the low-temperature ³¹P NMR. Rotamers could not be frozen out with the smaller ligands PMePh₂, PMe₂(*t*-Bu), or PPr₂(*t*-Bu). Two rotamers can be seen in the 0 °C ¹H NMR spectrum of *trans*-PdCl₂[PH(*t*-Bu)₂]₂.¹⁷³

A nonequivalence of H₁ and H₄ at low temperature in **65** with L = PCy₃ has been attributed to restricted rotation about the Pt-P bond.¹⁷⁴ This behavior was not observed with the smaller L = PPh₃.

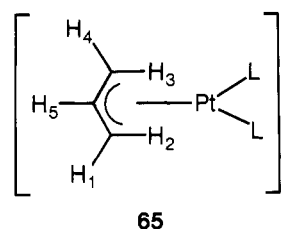

V. Unusual Reactions and Products

Changing the size of ligands frequently gives an unexpected reaction or unusual product. We have seen several examples in earlier sections. Here we are concerned primarily with products isolated from stoichiometric reactions. Section VI deals with catalytic reactions.

A. Displacement of Other Ligands

PPh₃ displaces H₂ in eq 21. The larger (and more basic) PCy₃ gives eq 22.¹⁷⁵

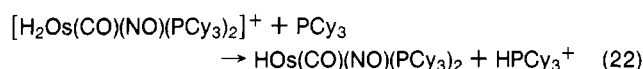
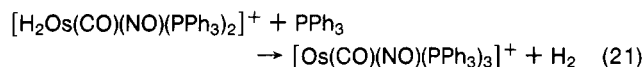

Reactions of various monodentate phosphorus ligands with (RC≡CR')Co(CO)₄ (2:1 ratio in refluxing benzene) gave disubstituted (RC≡CR')Co(CO)₂L₂ complexes for L = P(OMe)₃, PBu₃, P(*i*-Bu)₃, PPh₃, PPh₂(*sec*-Bu), PPhCy₃ and PCy₃. P(*i*-Pr)₃, P(*sec*-Bu)₃ and P(*o*-Tol)₃ did not react at all, even in refluxing toluene. Under these conditions, excess P(OMe)₃ gave tetrasubstituted (RC≡CR')Co(CO)₂L₄.¹⁷⁶

Several years ago, King¹⁷⁷ tried to prepare M(CO)₃[P(NMe₂)₃]₃ (M = Cr, Mo, W) by the reaction of the phosphine with (cycloheptatriene)M(CO)₃. The reaction gave *trans*-M(CO)₄L₂ instead. He attributed the failure to give trisubstitution to a special electronic effect (interaction of P with the N lone pairs). Actually P(NMe₂)₃ is very similar sterically (and electronically) to P(*i*-Pr)₃. A similar failure to achieve trisubstitution has been found more recently for L = PCy₃ by Moers and Reuvers,¹⁷⁸ who also obtained only *trans*-M(CO)₄L₂. In contrast, the smaller PMe₃ easily forms *cis*-M(CO)₄L₂, M(CO)₃L₃ and even M(CO)₂L₄.¹⁷⁹

Schoenberg and Anderson¹⁸⁰ found that the degree of photochemical CO substitution on pyrazolylboratocarbonylmanganese(I) complexes **66** and **67** (Table LIX) decreases in increasing Θ , or on putting methyl groups on the pyrazolyl rings.

The maximum degree of substitution found for group 6B hexacarbonyls under UV irradiation is shown in Table LX. The largest ligand replaces only four CO's from the smallest metal.

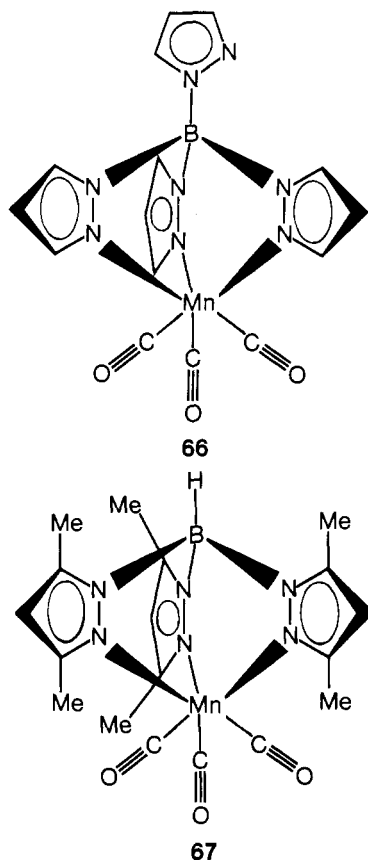

B. Unusual Complexes of Arenes, Tetramethylethylene, CO₂, N₂, and Hydrides

Unusual complexes (arene)Ni[Cy₂P(CH₂)_nPCy₂] (arene = benzene, naphthalene, or anthracene; *n* = 2 or 3) and (naphthalene)Ni(PCy₃)₂ can be prepared with very bulky ligands.¹⁸¹ Similar complexes of Me₂PCH₂CH₂PMe₂ or PMe₃ are unknown because of the stability of Ni(Me₂PCH₂CH₂PMe₂)₂ or Ni(PMe₃)₄.

The reaction of tetramethylethylene (TME) with Ni(Cy₂P-CH₂CH₂PCy₂) gives the olefin complex, whose x-ray crystal structure has been determined.¹⁸² The similar reaction of TME with the more crowded Ni(PCy₃)₂ does not go. Ethylene forms stable complexes in both cases.

Carbon dioxide complexes are still rare, presumably because of the weakness of bonding in most cases. The crystal structure of (CO₂)Ni(PCy₃)₂ has been reported.¹⁸³ The authors state that the stability of (CO₂)NiL₂ complexes depends on the basicity of L. It is clear, however, that steric effects are also very important.

The role of steric and electronic factors in the formation of (N₂)NiL₃ complexes was discussed in section IV.E. Green and Silverthorn¹⁸⁴ have similarly used a large, electron-donating phosphine to prepare (N₂)Mo(C₆H₆)(PMeCy₂)₂. Smaller ligands under the same conditions give Mo(C₆H₆)L₃ complexes.

While the reaction of phosphines with [(cyclooctene)₂RhCl]₂ is a common method for preparing RhClL₃ complexes, a similar reaction of PCy₃ under nitrogen gives (N₂)RhCl(PCy₃)₂.¹⁸⁵

Unusual transition metal hydrides can be stabilized through steric effects. Thus, while HNiBrL₂¹⁸⁶ and HPdBrL₂¹⁸⁷ with L = PEt₃ decompose rapidly at room temperature, the corresponding complexes with L = P(*i*-Pr)₃ or PCy₃ are stable and isolable.

Attempts to reduce *trans*-HPtClL₂ to *trans*-H₂PtL₂ leads to decomposition with small L = PMe₂Ph, PEt₃, AsEt₃, or PPh₃. H₂PtL₂ compounds can, however, be prepared with PMe₂(*t*-Bu), PEt₂(*t*-Bu), PBu₂(*t*-Bu), PBz₂(*t*-Bu), PPr(*t*-Bu)₂, PBz(*t*-Bu)₂, and PCy₃.¹⁸⁸ The more bulky the L, the more stable the complex. The crystal structure of *trans*-H₂Pt(PCy₃)₂ has been reported.²² An

TABLE LIX. Degree of Photochemical Substitution^a of Pyrazolylboratotriscarbonylmanganese(I) Complexes

L	66	67
PF ₃	1,2	1,2
P(OMe) ₃	1,2	1
P(OPh) ₃	1,2	1
PMe ₃	1	1
PCl ₃	1	0
PBu ₃	1	1
PPh ₃	1	0
P(<i>i</i> -Pr) ₃	1	0
PCy ₃	1	0
P(C ₆ F ₅) ₃	0	0

^a From ref 180.

TABLE LX. Maximum Degree of Photochemical Substitution^a on M(CO)₆

L	Cr	Mo	W
PF ₂ (OPr)	6	6	6
PF(OMe) ₂	6	6	6
P(OMe) ₃	5	6	5
P(OMe) ₂ Me	5	5	5
P(OMe)Me ₂	5	5	5
PMe ₃	4	5	5

^a From ref 203.

earlier report¹⁸⁹ of the preparation of this and other H₂PtL₂ complexes by the AlR₃ reduction of Pt(acac)₂ appears to be incorrect.¹⁸⁸

C. Unusual Coordination Numbers

With small L, the preferred coordination number for zerovalent Ni, Pd, and Pt is 4.^{2,9} This gives the metal an inert gas configuration of 18 electrons. ML₃ complexes can be isolated with PEt₃,^{83,119} P(O-*o*-Tol)₃,¹⁹⁰ PPh₃,^{83,191} or PBz₃.⁸³ Still larger ligands P(*i*-Pr)₃,⁸³ PCy₃,^{23,83,192} PPh(*t*-Bu)₂,⁸³ and P(*t*-Bu)₃⁶⁵ can give 14-electron ML₂ complexes. X-ray structures have been reported for Pd[PPh(*t*-Bu)₂]₂,^{65,193} Pd(PCy₃)₂,¹⁹³ and Pt(PCy₃)₂.²³

These ML₂ complexes appear to be the first structurally characterized exceptions to the 16- and 18-electron rule.¹²⁸

Unusual five-coordinate Pt(II) complexes PtX₂L₃ (X = Br, I) can be prepared with L = PMe₂Ph but not with PEt₃ or PPh₃.¹⁹⁴ CoBr₂L₃ complexes can be prepared when L = PHPh₂ but not PHCy₂; PMe₃ or PMe₂Ph but not PMePh₂, PPh₃, or PCy₃.¹⁹⁵ Co(CN)₂L₃ can be prepared when L = PHCy₂ or PMePh₂ but not PPh₃ or PCy₃.¹⁹⁵ While a number of ML₅⁺ complexes are known with L = P(OCH₂)₃CMe, P(OMe)₃, or P(OEt)₃, none have been prepared with L as large as PMe₃ (θ = 118°) or P(OPh)₃ (128°).¹⁶⁶ Co(PMe₃)₄⁺ does not react with PMe₃ to form a five-coordinate complex but does add PHMe₂¹⁹⁶ to give Co(PMe₃)₄(PHMe₂)⁺.

Though Ir(III) complexes are usually six-coordinate (with 18 electrons), reactive 16-electron HIrCl₂L₂ complexes can be prepared with L = PMe(*t*-Bu)₂, PEt(*t*-Bu)₂, and PPr(*t*-Bu)₂.¹⁹⁷ Similarly, the unusual HMCl(CO)L₂ complexes (M = Ru, Os) can be prepared when L = PCy₃.¹⁹⁸ A similar preparation with PPh₃ gives HMCl(CO)L₃.¹⁹⁹ NReCl₂L_n complexes form with *n* = 3 when L = PMe₂Ph, PEt₂Ph, PPr₂Ph, and PMePh₂ but *n* = 2 when L = PEtPh₂, PPrPh₂, or PPh₃.²⁰⁰

D. Products with Unusual Structures

A number of complexes of bulky phosphines have been found with novel structures or modes of bonding. A bridging cyclopentadienyl group occurs in **68** [L = PPh₃, P(*i*-Pr)₃, or PCy₃]; the x-ray structure has been determined for L = P(*i*-Pr)₃.²⁰¹

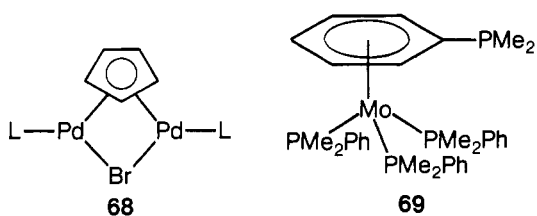

Though $\text{Mo}(\text{PF}_3)_6^{202}$ and $\text{Mo}[\text{P}(\text{OMe})_3]_6^{203}$ are known, reduction of $\text{MoCl}_3(\text{THF})_3$ in the presence of excess PMe_2Ph gives " $\text{Mo}(\text{PMe}_2\text{Ph})_4$ "²⁰⁴ with structure **69**.²⁰⁵ $\text{M}(\text{CO})_4\text{L}_2$ complexes ($\text{M} = \text{Cr}, \text{Mo}$ or W) can be readily prepared from $\text{M}(\text{CO})_6$ with $\text{L} = \text{P}(p\text{-Tol})_3$ or $\text{P}(m\text{-Tol})_3$, but no disubstituted products are formed with $\text{P}(o\text{-Tol})_3$. Attempts to force the reaction of $\text{M}(\text{CO})_5\text{P}(o\text{-Tol})_3$ with excess phosphine gave **70** instead.⁶³

Prolonged heating of RhCl_3 in 2-methoxyethanol with $\text{P}(p\text{-Tol})_3$ or $\text{P}(m\text{-Tol})_3$ gives the $\text{RhCl}(\text{CO})\text{L}_2$ complexes. With $\text{P}(o\text{-Tol})_3$, **71** is obtained.²⁰⁶

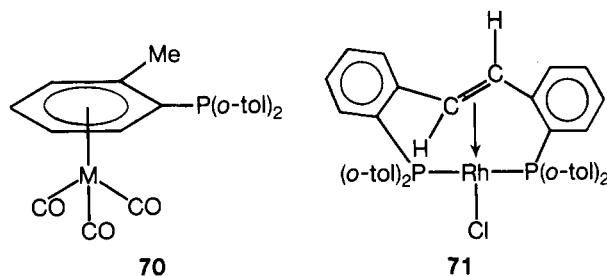

Reaction of $(\text{C}_{10}\text{H}_7)\text{FeH}(\text{dmpe})_2$ with $\text{P}(\text{OPh})_3$ or PEt_3 gives $\text{LFe}(\text{dmpe})_2$ complexes (and C_{10}H_8). A similar reaction with PPh_3 gives **72**.²⁰⁷

Reduction of $\text{Fe}(\text{II})$ salts in the presence of $\text{P}(\text{OMe})_3$ gives $\text{Fe}[\text{P}(\text{OMe})_3]_5$.²⁰⁸ A similar reaction with PMe_3 gives " $\text{Fe}(\text{PMe}_3)_4$ ", whose structure, by NMR, is **73**.^{209,210}

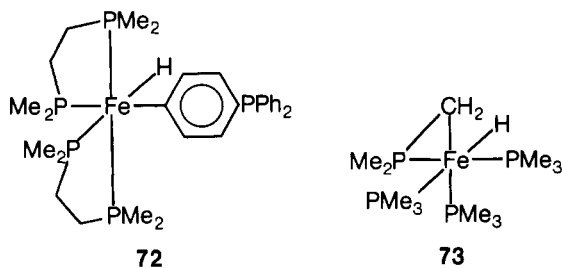

Hexakis(trifluoromethyl)benzene reacts with (*trans*-stilbene) PtL_2 with ring opening of the arene to give **74** with $\text{L} = \text{PMe}_3$. The reaction with $\text{L} = \text{PEt}_3$ gives **75** instead.²¹¹ Presumably **74** is too crowded to form with the larger phosphine.

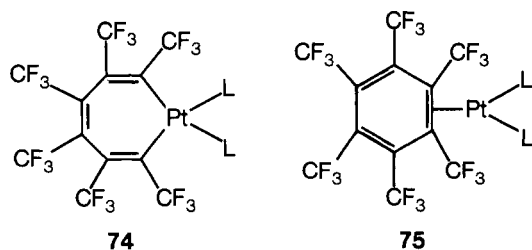

Cyclic polyphosphines $(\text{PR})_n$ form the five-membered ring **76** with $\text{R} = \text{Me}, \text{Et}, \text{Bu}$, or Ph but **77** with $\text{R} = i\text{-Pr}, \text{Cy}$, or $t\text{-Bu}$.²¹² Unfavorable steric crowding can be relieved by trans alternation of R groups in **77**.

Unusual large ring compounds **78–80** can be formed using $(t\text{-Bu})_2\text{P}(\text{CH}_2)_{10}\text{P}(t\text{-Bu})_2$.²¹³ The bulky $t\text{-Bu}$ groups prevent the phosphorus atoms from taking up mutually cis positions. A long chain is required to form mononuclear complexes. Thus, **79** could not be prepared with $(t\text{-Bu})_2\text{P}(\text{CH}_2)_5\text{P}(t\text{-Bu})_2$. Some x-ray structures have been reported.²¹⁴

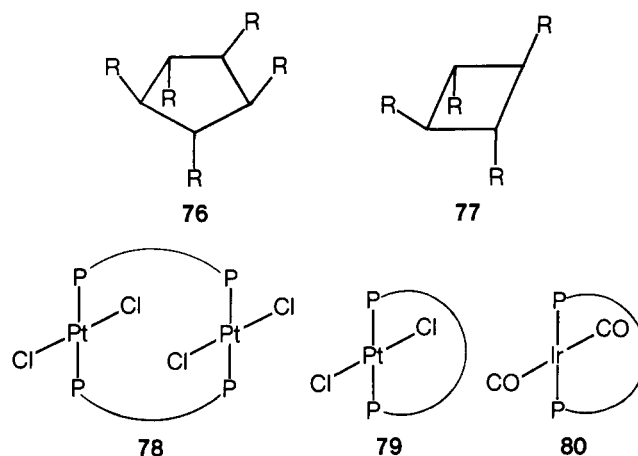

Reaction of $[\text{RhCl}(\text{CO})_2]_2$ with $\text{Ph}_2\text{P}(\text{CH}_2)_n\text{PPh}_2$ gives **81** when $n = 1, 3$, or 4 but **82** when $n = 2$.²¹⁵

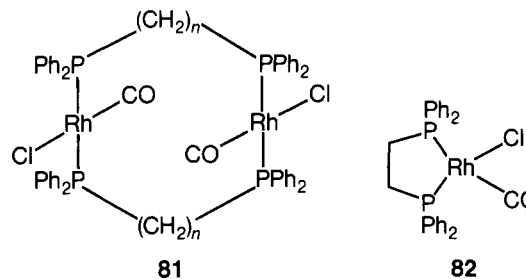

Attempts to prepare $\text{NiBr}_2[\text{P}(t\text{-Bu})_3]_2$ by the usual reaction of NiBr_2 with the phosphine²¹⁶ in alcohol gave instead $[\text{HP}(t\text{-Bu})_3]^+[\text{NiBr}_3\text{P}(t\text{-Bu})_3]^-$.²⁴

E. Unusual Oxidation States

While the reaction of $\text{RhCl}_3 \cdot 3\text{H}_2\text{O}$ with PEt_3 gives the RhCl_3L_3 complex,²¹⁷ similar reactions of PCy_3 ,²¹⁸ $\text{PET}(t\text{-Bu})_2$,²¹⁹ or $\text{P}(o\text{-Tol})_3$ ²⁰⁶ give the paramagnetic $\text{Rh}(\text{II})$ complexes RhCl_2L_2 . $\text{IrCl}_2(\text{PCy}_3)_2$ has also been prepared.²⁰⁶ The $\text{Ir}(\text{II})$ complex **83** has been prepared from IrCl_6^{3-} and $\text{P}(t\text{-Bu})_2(o\text{-C}_6\text{H}_4\text{OMe})$ and its x-ray structure determined.²²⁰ Note that the bulky $\text{P}(t\text{-Bu})_2$ groups adopt mutually trans positions.

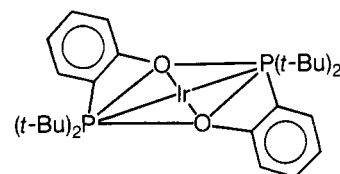

83

$\text{NiX}(\text{PPh}_3)_3$ ²²¹ ($\text{X} = \text{Cl}, \text{Br}$ or I) and $[\text{NiX}(\text{PCy}_3)_2]_2$ ²²² ($\text{X} = \text{Cl}$ or Br), both containing bulky L , are among the few examples reported of $\text{Ni}(\text{I})$ complexes containing monodentate phosphines.

$\text{Ni}(\text{I})$ complexes NiXp_3 [$\text{X} = \text{Cl}$ or Br , $\text{p}_3 = \text{CH}_3\text{C}(\text{CH}_2\text{PPh}_2)_3$] have been prepared from the reaction of NiX_2 with p_3 in the presence of NaBH_4 .²²³ NiI_2 reacts directly with p_3 to give $\text{NiI}p_3$, whose x-ray structure has been determined.²²⁴ $\text{NiCl}(\text{Cy}_2\text{PCH}_2\text{CH}_2\text{PCy}_2)$ and $\text{NiI}(\text{Cy}_2\text{PCH}_2\text{CH}_2\text{PCy}_2)$ have also been reported.²²⁵

The nickel atoms in **84** are formally $\text{Ni}(\text{I})$, but the complex itself is diamagnetic; the diphosphine shown is $\text{Cy}_2\text{PCH}_2\text{CH}_2\text{PCy}_2$.

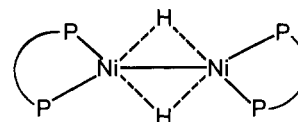

84

Using p_3 , Sacconi and co-workers²²⁶ have isolated a related complex, **85**, and determined its crystal structure.

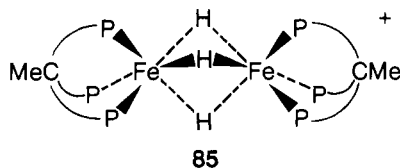

VI. Homogeneous Catalysis

Over the past 20 years, the development of homogeneous catalysis has had a major impact on the growth of organometallic chemistry, much of which has been justified on the basis of the insight it gives into catalytic reactions. Several have proven practical for large-scale (over 100 million pounds per year) industrial syntheses of organic compounds. While our ability to design catalyst systems is still in its infancy, it is clear that phosphorus ligands are often involved and that their steric and electronic characters play extremely important roles. Learning to control catalytic reactions to give high yields of desired products under mild conditions will become increasingly important as the supply of petroleum for energy and feedstocks dwindles in the years ahead.

A. Reaction Rates

The rate of hydrogenation of cyclohexene by $RhClL_3$ catalysts increases in the sequence $L = P(p-C_6H_4F) \ll PPh_3 < P(p-C_6H_4OCH_3)$,²²⁷ indicating that electron donation by aryl phosphines increases activity, probably by increasing the rate and extent of oxidative addition by H_2 .²⁷ Replacing phenyl by ethyl, however, decreases the rate in the sequence $PPh_3 > PEtPh_2 > PEt_2Ph > PEt_3$.²²⁷ The difficulty here occurs at the next stage of the cycle, where L dissociation from the 18-electron H_2RhClL_3 is required before the olefin can coordinate.¹²⁸ The tripod phosphine complex **86** reacts readily with H_2 but is not a hydrogenation catalyst²²⁸ because the phosphorus atoms in the dihydride do not dissociate easily. Rapid dissociation of the PPh_3 trans to H in **87** has been demonstrated by NMR line-shape

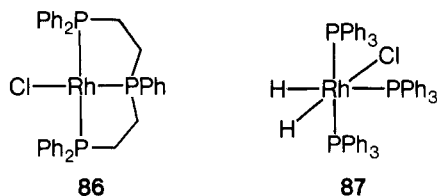

studies, but the $H_2RhCl(PPh_3)_2$ intermediate has not been detected spectroscopically.²⁷ H_2RhClL_2 complexes can, however, be isolated with bulky ligands²²⁹ like $PMe(t-Bu)_2$, $P(t-Bu)_3$,²³⁰ or PCy_3 .¹⁸⁵ They are active hydrogenation catalysts.^{185,230}

A $HRhL_4$ catalyst an order of magnitude more active than $HRh(PPh_3)_4$ or $RhCl(PPh_3)_3$ for 1-hexene hydrogenation has been reported using $L = 5$ -phenyl-5*H*-dibenzophosphole (**88**). The enhanced activity was attributed to the rigid, bulky nature of the ligand.²³¹

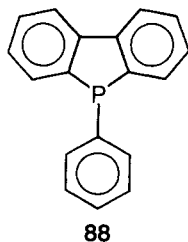

The greater activity of **89** than **90** in olefin hydrogenation has been attributed to the more ready dissociation of an $L = P(OPh)_3$ in the former.²³² Hydrogenation is inhibited in both cases by the addition of $P(OPh)_3$.

TABLE LXI. Relative Hydrogenation Rates^a of Styrene by L + $[RhCl(C_2H_4)_2]_2$ (P:Rh = 2.1:1) in Benzene at Ambient Temperature and 1.1 atm of H_2

L	Rel rate	L	Rel rate
PPh_3	2.8	$Ph_2P(CH_2)_5PPh_2$	0.5
$PEtPh_2$	(1.00)	$Ph_2P(CH_2)_6PPh_2$	0.22
$Ph_2PCH_2PPh_2$	0.5	<i>cis</i> - $Ph_2PCH=CHPPh_2$	0.07
$Ph_2P(CH_2)_2PPh_2$	0.04	$Ph_2PCH_2OCH_2PPh_2$	0.03
$Ph_2P(CH_2)_3PPh_2$	1.75	diop	0.17
$Ph_2P(CH_2)_4PPh_2$	0.25		

^a From ref 234.

TABLE LXII. Hydroformylation of 1-Hexene at 160 °C and 1000 psig; $H_2:CO = 1.2:1$. Cobalt Carbonyl Catalyst

L	% ^a	L	% ^a
PBu_3	89.6	PEt_2Ph	84.6
PEt_3	89.6	$PEtPh_2$	71.7
PPr_3	89.5	PPh_3	62.4
$P(i-Pr)_3$	85.0		

^a Linear aldehyde and alcohol. From ref 239.

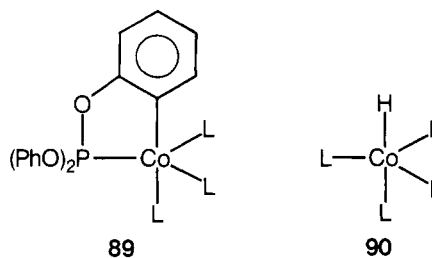

Catalytic hydrogenation of benzene to cyclohexane is three times as fast with $\pi-C_3H_5Co[P(OMe)_3]_2P(O-i-Pr)_3$ as with $\pi-C_3H_5Co[P(OMe)_3]_3$.²³³

The rate of styrene hydrogenation by rhodium catalysts containing $Ph_2P(CH_2)_nPPh_2$ depends markedly on the value of n (Table LXI).²³⁴ Quite different relative rates are obtained if the substrate is changed to α -acetamidocinnamic acid.

The rate of addition of active hydrogen compounds to butadiene in a $Ni(acac)_2/P(OR)_2/NaBH_4$ system increases in the order $R = Me < Et < i-Pr$.²³⁵ Using preformed NiL_4 catalysts, only a trace of morpholine reacted in 1 h at 100 °C when $L = P(OEt)_2Ph$, while 96% reaction was observed with $P(O-i-Pr)_2Ph$.²³⁶

Both the rates and product distributions of butadiene cycloligomerization with $Ni(0)/L$ catalysts depends on L .^{237a} The same is true in reactions involving added ethylene.^{237b}

B. Product Distributions

The major product of propylene dimerization in a $\pi-C_3H_5Ni-LAlCl_3$ catalyst system changes from 2-methylpentenes to 2,3-dimethylbutenes on increasing the size of L in the series PMe_3 , PEt_3 , $P(i-Pr)_3$.^{237c}

It has been known for some time that the addition of phosphines to the cobalt carbonyl catalyzed hydroformylation slows the reaction but gives a higher percentage of the desired linear aldehyde and alcohol products.²³⁸ Tucci²³⁹ observed the product distributions shown in Table LXII.

A more extensive study of $HRh(CO)_{4-n}L_n$ catalyzed hydroformylation by Pruett and Smith²⁴⁰ showed that both steric and electronic effects of L are important. Table LXIII shows that increased electron donation by para-substituted aryl phosphites decreases the percentage of linear aldehyde. A greater decrease is caused by making L more bulky. The role of ligand size can be understood by referring to Scheme I, where R^2 and R^1 refer to isomeric secondary and primary alkyls. Increasing the size of L should increase K_1 , K_2 , and K_3 . (Greater crowding in a

TABLE LXIII. Hydroformylation of 1-Octene at 90 °C and 80–100 psig, H₂:CO = 1:1. HRh(O)_{4-n}L_n Catalyst

L	% ^a	L	% ^a
P(O- <i>p</i> -C ₆ H ₄ Cl) ₃	93	P(OBu) ₃	81
P(OPh) ₃	86	P(O- <i>o</i> -Tol) ₃	78
P(O- <i>p</i> -C ₆ H ₄ Ph) ₃	85	P(O- <i>o</i> -C ₆ H ₄ Ph) ₃	52
P(O- <i>p</i> -C ₆ H ₄ OCH ₃) ₃	83	P[O-2,6-C ₆ H ₃ (Me) ₂]	47

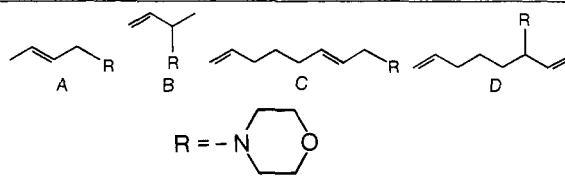
^a Linear aldehyde. From ref 240.**TABLE LXIV. Percentage of Products^a Produced for Morpholine and Butadiene with NiCl₂/L/NaBH₄ (1:2:1) at 20 °C in 6–9 h**

L	A	B	C	D
P(O- <i>i</i> -Pr) ₂ Ph	13	77	8	1
P(O- <i>o</i> -Tol) ₃	3	27	64	6
PPh ₃	2	6	75	17
P(O- <i>o</i> -C ₆ H ₄ Ph) ₃			85	15

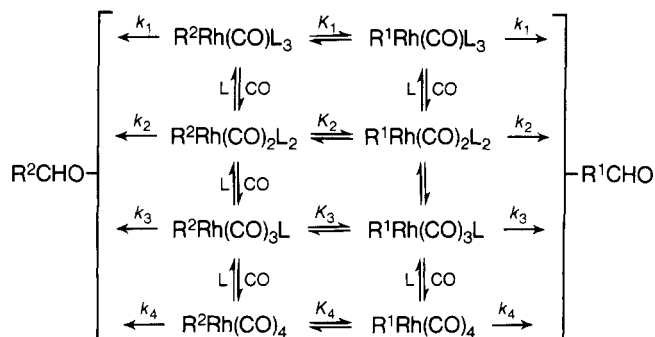
^a R. Baker, A. Onions, R. J. Popplestone and T. N. Smith, *J. Chem. Soc., Perkin Trans. 2*, 1133 (1975).**SCHEME I**

complex decreases the stability of a secondary alkyl more than a primary one.) But $K_1 > K_2 > K_3 > K_4$. Increasing the size of L improves the ability of CO to compete with L for coordination sites and increases the fraction of Rh present as $\text{RRh}(\text{CO})_3\text{L}$ and $\text{RRh}(\text{CO})_4$. In the limit of very large L, the product distribution will be that of a phosphine-free system.

Table LXIV shows the effect of changing L on the product distribution in the reaction of morpholine with butadiene. Larger L's compete less favorably with butadiene for coordination, allowing the butadiene to dimerize to a greater extent.

The trimers produced in the oligomerization of methylenecyclopropane are markedly affected by the size of L, showing a smooth transition to cyclic products as the size of L increases (Table LXV). Apparently the hydride transfer step required to give open chain products becomes less favorable relative to carbon-carbon coupling.

Trost and Strege²⁴¹ have shown that the position of attack of nucleophiles on **91** can be shifted to the primary carbon of the π -allyl by increasing the size of L. The result was explained in

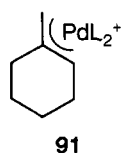
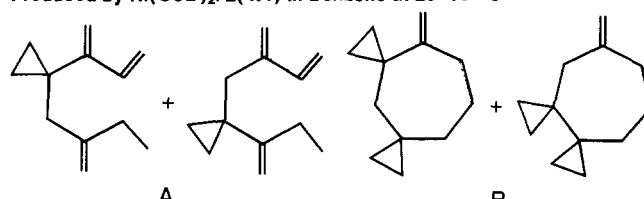
**TABLE LXV. Percentage of Methylene-cyclopropane Trimers^a Produced by Ni(COD)₂/L (1:1) in Benzene at 25–60 °C**

	% A	% B
PEt ₃ ^b	92	2
PPh ₃	89	6
P(<i>i</i> Pr) ₃	78	18
PCy ₃	72	23
P(<i>i</i> -Pr) ₂ (<i>t</i> -Bu)	18	69
P(<i>t</i> -Bu) ₃	0	80

^a P. Binger and J. McMeeking, *Angew. Chem., Int. Ed. Engl.* **12**, 995 (1973). ^b P. Binger, private communication.

terms of crowding in the (olefin)PdL₂ complexes which are the presumed primary products.

C. Asymmetric Induction

A discussion of steric effects on catalytic reactions would not be complete without mentioning the rapidly growing area of asymmetric induction. In 1968, Knowles and Sabacky²⁴² reported the first catalytic asymmetric hydrogenation, employing a Rh catalyst with the optically active ligand (–)PMePh(*i*-Pr). Later Dang and Kagan²⁴³ prepared the optically active amino acid *N*-acetylphenylalanine (eq 23) using a Rh catalyst containing the optically active diphosphine diop (**92**). Enantiomeric excesses of up to 96% have been achieved using **93** as the catalyst.²⁴⁴

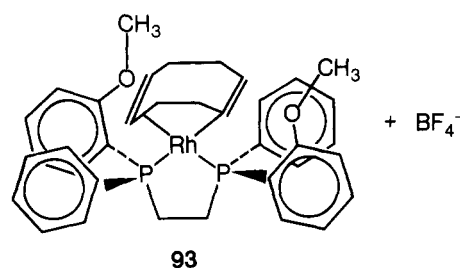
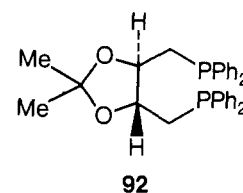
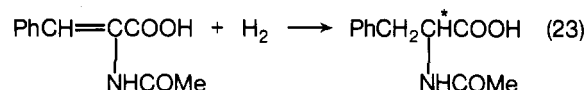

Though Knowles and co-workers have argued that electrostatic interactions of the methoxy group with the substrate are involved in this case, it is clear that steric effects are very important and perhaps solely responsible for asymmetric induction in systems without methoxy substituents.²⁴⁵

Table LXVI shows the effects of varying the structure of some optically active monodentate phosphines on the enantiomeric excess (L configuration) of α -amino acid produced by the hydrogenation of prochiral olefins **94** and **95** by [(1,5-cyclooctadiene)RhL₂]BF₄.

A catalyst for asymmetric hydrogenation can be prepared from the reaction of RuCl₂(PPh₃)₃ with (+)-diop to give **96**.²⁴⁶ The reaction of RuCl₂(PPh₃)₃ with Ph₂PCH₂CH₂PPh₂ gives a coord-

TABLE LXVI. Enantiomeric Excess in Asymmetric Hydrogenation^a by [(1,5-COD)RhL₂]BF₄ at 25 °C

L	Substrate	P _{H₂} (atm)	ee %
PMePrPh	94	3.5	28
PMePh(<i>o</i> -C ₆ H ₄ OMe)	94	3.5	58 ^b
PMeCy(<i>o</i> -C ₆ H ₄ OMe)	94	0.7	90
PMeBz(<i>o</i> -C ₆ H ₄ OMe)	95	3.5	47
PMe(<i>i</i> -Bu)(<i>o</i> -C ₆ H ₄ OMe)	95	3.5	49
PMe(<i>i</i> -Pr)(<i>o</i> -C ₆ H ₄ OMe)	95	3.5	85
PMeCy(<i>o</i> -C ₆ H ₄ OMe)	95	0.7	88
PMeCy(2Me-4-BrC ₆ H ₃)	95	3.5	74

^a W. S. Knowles, M. J. Sabacky, and B. D. Vineyard, *Adv. Chem. Ser.*, No. 132, 274 (1974). ^b This run was by the anion procedure. The others were by the free acid procedure.

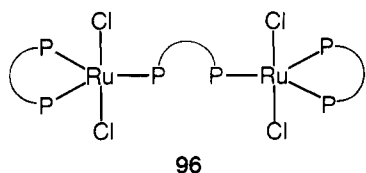
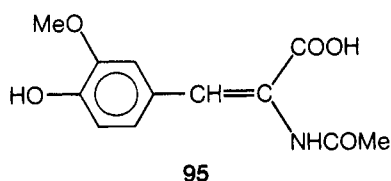
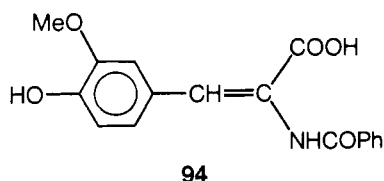

dinatively saturated complex RuCl₂(Ph₂PCH₂CH₂PPh₂)₂ which is inactive under similar conditions.

Asymmetric hydroformylation of olefins using optically active phosphines has been demonstrated.²⁴⁷ Though little work has been reported involving steric effects in the phosphines, it is clear that the size of substituents on the olefin is very important in controlling which face of the olefin preferentially coordinates.

Asymmetric hydrosilylation of carbonyl compounds has been used to prepare asymmetric alkoxy silanes (eq 24).²⁴⁸ The preferred configuration of the product can be understood in terms of minimizing steric interactions in the intermediates; **97** is more stable than **98**.

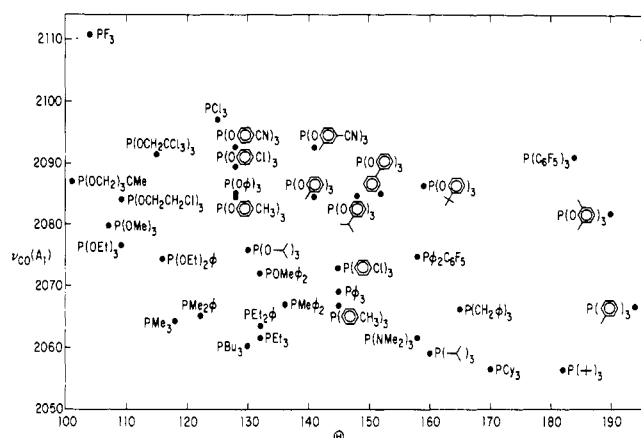
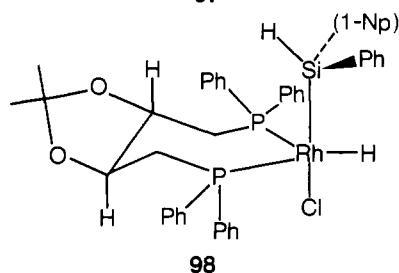
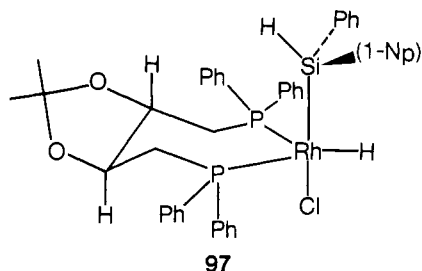
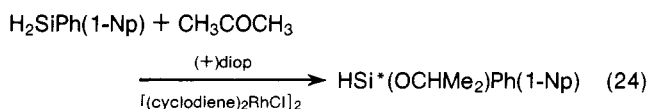

Figure 25. Steric and electronic map.



VII. Steric and Electronic Map

If a measurable parameter Z is dominated by steric effects, the dependence can be readily shown by plotting Z against θ , such as in Figures 7 and 9. [Z might be the log of a rate constant, an infrared stretching frequency, a metal-phosphorus coupling constant, etc.] In cases where Z is dominated by electronic effects, a plot of Z against ν is appropriate. In the general case, Z may depend on both steric and electronic effects. In addition to displaying the dependence graphically, it might be desirable to describe it in terms of its percentages of steric and electronic character, as Swain and Lupton^{249a} have done with electronic field and resonance effects in organic chemistry. A step in this direction is what I call the Steric and Electronic Map of phosphorus ligands, shown in Figure 25. The position of any ligand on the map can be determined by its values of ν and θ , determined from the Appendixes or by a few very simple experiments. A parameter Z can be represented by a vertical height above the map. Enough experimental values of Z will define a three-dimensional surface—a sort of landscape. A pure steric effect will give a surface sloping east or west but not north and south. A purely electronic effect will give a north-south slope. If the surface is a plane, it can be represented by

$$Z = a\theta + b\nu + c \quad (25)$$

The percentage of steric character then might be defined by

$$\% \text{ steric character} = 100[a/(a + b)] \quad (26)$$

In the more general case of a nonplanar surface, the % steric character at a particular point could be defined in terms of $\delta Z/\delta\theta$ and $\delta Z/\delta\nu$.

An example of a surface can be seen in Figure 26, where the positions of the points above the plane represent the first ionization potentials of the electron pair of a number of free phosphorus ligands, as determined by UV photoelectron spectroscopy. The device shown, which I call a "steric and electronic box", can be readily constructed from metal rods, beads, and 1 1/4 in. thick styrofoam sheet available at many hobby and craft stores. Figures 27 and 28 show surfaces defined by ¹³C NMR chemical shifts of the carbonyls in Ni(CO)₃L complexes and enthalpies of reaction of phosphorus ligands with *trans*-[MePt(PMe₂Ph)₂(THF)]⁺. The former is obviously electronically and the latter sterically controlled.

A surface defined by the percentage of a desired product in a homogeneous catalytic reaction could be of great help in selecting the best ligand to use in a particular system. The surface

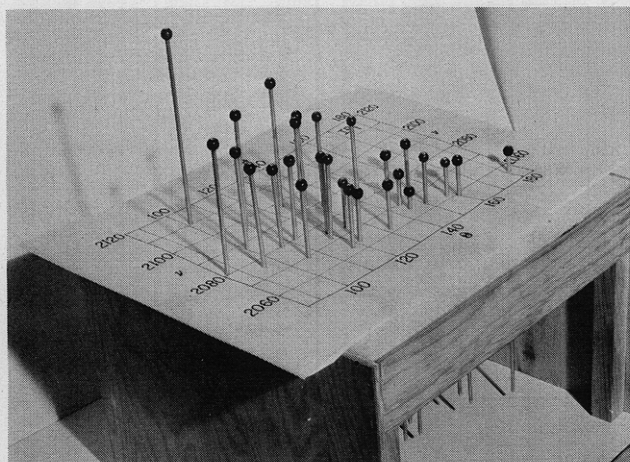

Figure 26. IP_1 of free phosphorus ligands in the gas phase. Data from references in Table XXVII. The height in inches is the number of electron volts above 7.0.

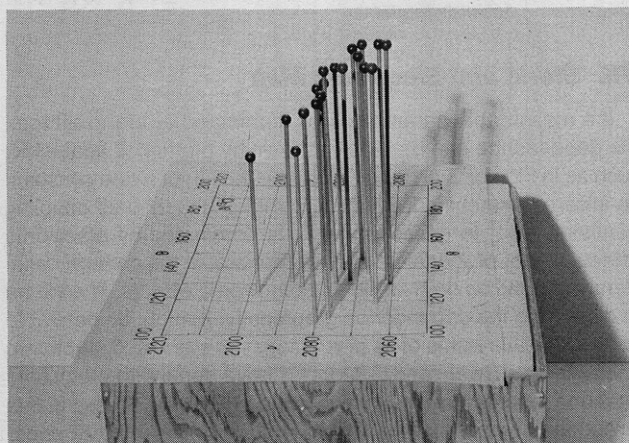
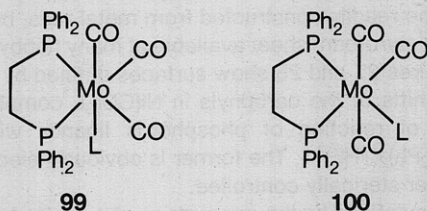

Figure 27. $\delta(^{13}C)$ of the carbonyls in $Ni(CO)_3L$ complexes, from ref 249b. The height in cm is the chemical shift (downfield from internal Me_4Si) in ppm beyond 180.

could, of course, depend on variables such as temperature, solvent, and ratios of reactants.

VIII. Steric Effects of Other Ligands

Though steric effects of ligands bonded by atoms other than phosphorus are strictly beyond the scope of this review, a few comments should be made. Other group 5 donors (ES_3) containing As, Sb, and Bi are expected to be slightly smaller than their P analogs. Models show that increasing M–E or E–C bond lengths by $\sim 0.1 \text{ \AA}$ decreases cone angles by 3 to 5° . Pauling's tetrahedral covalent radii for P, As, Sb, and Bi are 1.10, 1.18, 1.36, and 1.46 \AA .²⁵¹ Mean SES angles are also likely to be smaller for heavier group 5 donors. For example, the mean CSbC angle of 101.8° in $Fe(CO)_4SbPh_3$ ²⁵² is 2.4° smaller than the CPC angle in $Fe(CO)_4PPh_2$.²⁵³ The Sb–Fe bond (2.47 \AA) is 0.23 \AA longer. The smaller size of $L = SbPh_3$ has been used to explain the formation of isomer **99** while $AsPh_3$ and PPh_3 form **100**.²⁵⁴



It should be borne in mind that, though carbonyl stretching frequencies in $M(CO)_n(ER_3)_m$ complexes are nearly independent

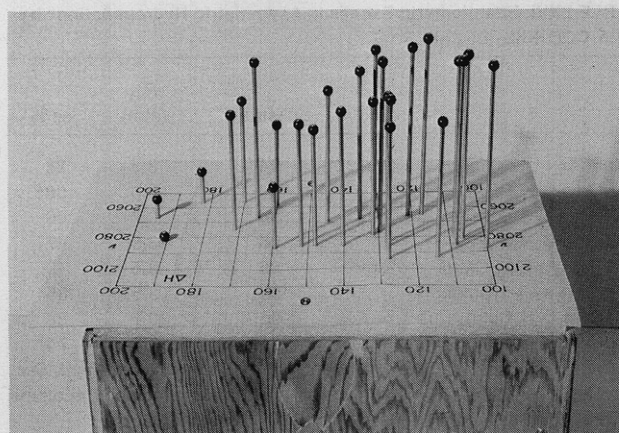
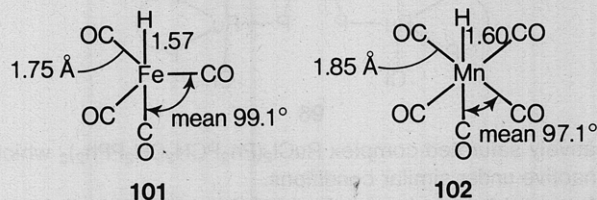

Figure 28. ΔH for reactions of $trans-[MePt(PMe_2Ph)_2(THF)]PF_6$ with excess L, from ref 250. The height in cm is one-half the number of kcal/mol.

of E, the M–E bond strengths can be very different and generally fall rapidly in the order $P > As > Sb > Bi$.

Ligand cone angles can be defined for ligands other than those bonded by group 5 donor atoms. A few values for common types are given in Appendix C. The importance of steric effects in compounds not containing group 5 atoms is illustrated by the few following examples.

The structure of $HFe(CO)_4^-$ (**101**)²⁵⁵ shows a greater bending of equatorial carbonyls toward the hydride than does $HMn(CO)_5$ (**102**),²⁵⁶ whose metal has a larger covalent radius. A still greater deviation from idealized geometry is shown by $HCo(PF_3)_4$.²⁵⁷



The oxidation potentials of complexes **103** depend on the size of the macrocyclic tetraamine ring; increasing the ring size from 14 to 16 makes it more difficult to go from Ni(II) to Ni(III) by about 0.3 eV .²⁵⁸ Busch and co-workers have also shown that the fit

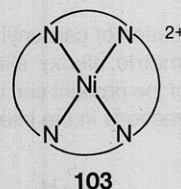

of the cation in the "hole" formed by the four N donors also affects the UV absorption spectrum.²⁵⁹ Increasing the M–N bond lengths beyond an optimum value (by increasing ring size) causes red shifts in the UV transitions, reminiscent of effects seen in section III.C. It is intriguing to note that the UV spectra of transition metal complexes can be changed by subjecting them to high pressures.²⁶⁰

Brintzinger²⁶¹ and co-workers have claimed that the insertion of WCp_2 into aromatic C–H bonds, not observed for the Cr and Mo analogues, is largely due to reduced steric crowding in the transition state of the larger metal.

The activation energy to bridge-terminal H interchange is much larger in $Cp_2VH_2BH_2$ than in $Cp_2NbH_2BH_2$. Marks and Kennelly^{262a} attribute this to the larger ionic radius of Nb. Significantly the $Cp_2M(allyl)$ complex is η^1 for $M = V$ and η^3 for $M = Nb$.

Formation of Schrock's alkylidene (eq 28) in the reduction of TaR_3Cl_2 complexes by thallium cyclopentadienide must de-

TABLE LXVII. Equilibrium Distribution^a of Products in the Reaction of HZrClCp₂ with RC≡CR'

R	R'	R	
		(Zr)	(Zr) ^b
H	Bu	>98	<2
Me	Et	89	11
Me	Pr	91	9
Me	<i>i</i> -Bu	>95	<5
Me	<i>i</i> -Pr	>98	<2
Me	<i>t</i> -Bu	>98	<2

^a D. W. Hart, T. F. Blackburn, and J. Schwartz, *J. Am. Chem. Soc.*, **97**, 679 (1975). ^b (Zr) = ZrClCp₂.

pend^{262b} on the conflicting steric requirements of the groups R and Cp, as seen in the following sequence of reactions:

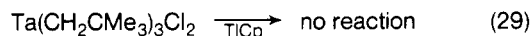
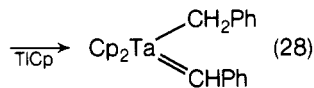
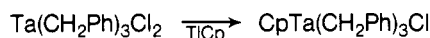
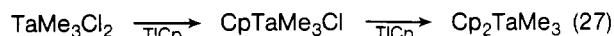

Neopentyl groups are too large to permit even the first stage of reduction.

Addition of HZrClCp₂ to unsymmetrically disubstituted acetylenes gives a mixture of vinyl zirconium derivatives in which the steric bulk of the alkyl substituents on the acetylene determines the direction of addition (Table LXVII). The bulky ZrClCp₂ preferentially goes on the smaller end of the acetylene.

Collman's "picket fence porphyrin"²⁶³ (Figure 29) and Baldwin's "capped" porphyrin complex²⁶⁴ both utilize organic superstructure on the porphyrins to protect the Fe-coordinated O₂ in a manner analogous to the biological protein. The possibilities of modifying chemical behavior through changing molecular structure have hardly begun to be explored.

IX. Summary

Steric effects are extremely important to structures, spectroscopic properties, and chemical behavior of phosphorus ligands and their complexes. Increasing the size of substituents on P will tend to:

- open the SPS angles and the angles between L and other ligands on a metal;
- increase the bond lengths of M to P and to other ligands;
- reduce the s character in the phosphorus lone pair, thus decreasing ¹J_{MP} and shifting δ(³¹P) to low field;
- increase the basicity of the lone pair;
- favor lower coordination numbers (possibly involving M–M bond cleavage);
- favor coordination of other ligands which are in competition for coordination sites;
- favor intramolecular oxidative addition reactions;
- favor isomers which are less crowded;
- increase the rates of dissociative reactions and decrease the rates of associative ones. If the L's become large enough, they can interfere with the coordination of other ligands which are normally strongly held, such as CO or O₂.

In order to reach conclusions about the relative importance of steric and electronic effects in a particular system, a wide range of ligand types should be used. The Steric and Electronic Map should be helpful, in conjunction with values of ν and θ from Appendixes A and B, and the additivity relationships.

It would be helpful to have cone angles from actual ligands

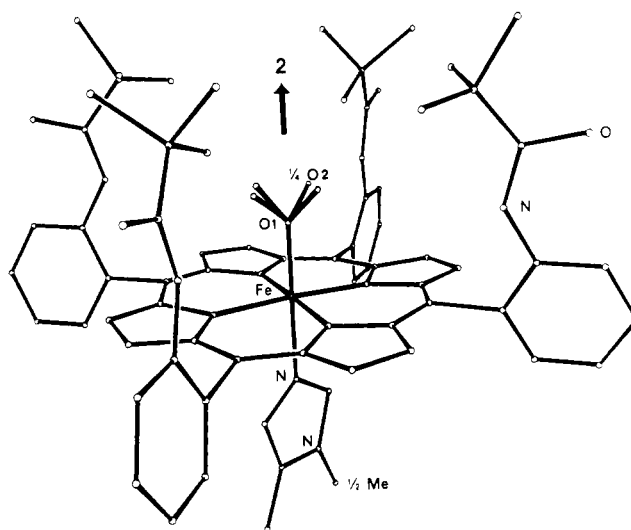

Figure 29. The O₂ complex of Collman's "picket fence porphyrin", showing the fourfold disorder in the O₂ position, from ref 263.

in x-ray crystal structures. Some efforts along these lines are underway in our and other²⁶⁵ laboratories. Hopefully someone in the near future will do the statistical analysis necessary to put the separation of phosphorus ligand steric and electronic effects on a sound mathematical basis. The idea of ligand cone angles should be extended to other types of ligands (such as those in Appendix C), and tested experimentally wherever possible. There is a great need at the present time for measurement of steric effects on heats of reaction. Calorimetric studies are in their infancy.²⁶⁶ Other areas in need of research are the role of steric effects in rates of reactions, electronic structure and spectra, and electrochemistry. The application of steric effects to the control of homogeneous catalytic reactions is probably the most important area and holds great promise for future research.

X. Addendum

Since writing this review, a number of relevant articles have come to my attention. In particular, a review^{267a} on tertiary phosphine ligands by Mason and Meek discusses steric effects and independently arrives at a number of the conclusions presented here. A book entitled "The Chemistry of Phosphorus" by Emsley and Hall^{267b} has only a short section on steric effects but provides broad coverage for all sorts of phosphorus chemistry. For the convenience of the reader, I have listed the following additions in the order in which they would have appeared in the text, with an appropriate section number.

II. An x-ray crystal structure shows that trimesitylphosphine (mesityl = 2,4,6-trimethylphenyl) has a mean C–P–C angle of 109.7°,^{268a} the largest value reported for a free phosphine. Trimesitylmethane, with a smaller central atom, has an even larger (C–C–C) angle of 115.9°.^{268b} CPK models show that P(mesityl)₃ has a ligand cone angle of 212°. The ³¹P chemical shift has an unusual value of +36.6 ppm, and the DS (Figure 9) is 0!^{268c}

The x-ray crystal structure of Mo(CO)₅[P(CH₂)₃(NCH₂)₃] has been solved to give a ligand cone angle of 102 ± 0.5° for the symmetric phosphine cage.²⁶⁹

X-ray studies of CuCl(PPh₃)₃ and CuCl(PMePh₂)₃ have been determined and compared, and the role of steric effects on the structures of 31 phosphine or arsine complexes of Cu(I) summarized.²⁷⁰

Graziani and co-workers²⁷¹ have found that increasing the size of the methylene chain (n = 0, 1, and 2) in complexes of the type

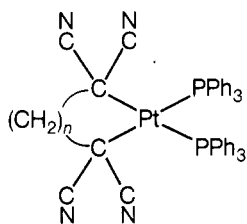

decreases the P–Pt–P angle from 101 to 93° and increases the Pt–P bond length from 2.29 to 2.33 Å.

The orange dithioformate complex $\text{Ru}(\text{S}_2\text{CH})(\text{PMe}_2\text{Ph})_4^+$ (I) isomerizes on heating to a purple complex (II) in which a bulky axial phosphine (P) has been pushed from Ru to C. ²⁷² Substituting the equatorial phosphines by the smaller $\text{L} = \text{P}(\text{OMe})_3$ causes the axial phosphine to move back to Ru, giving the yellow

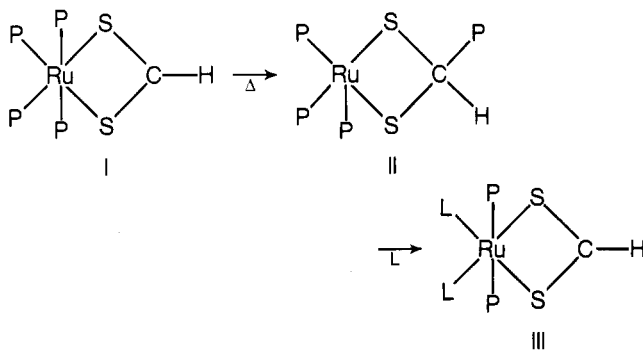

complex III. Treatment of II with the larger $\text{L}' = \text{P}(\text{OMe})_2\text{Ph}$ gives only the purple C-bonded IV.

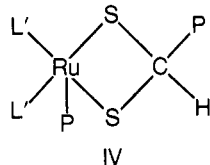

III.A. Values of $J(\text{PNP})$ in

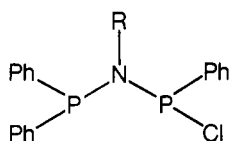

depend markedly on the size of R as follows: R = Me (+334), Et (+158), *i*-Pr (−29), and *t*-Bu (−35). ²⁷³

III.B. Verkade and co-workers ²⁷⁴ have shown that NO stretching frequencies in $(\text{NO})\text{NiL}_3^+$ complexes (where L is an acyclic, cyclic, or bicyclic phosphite) increase as the molecular constraint is increased. They find a good correlation between ν_{NO} and $^1J_{\text{PH}}$ in the corresponding HL^+ .

III.C. UV spectra of *trans*- $\text{IrCl}(\text{CO})\text{L}_2$ complexes show shifts to shorter wavelength as the size of L increases. ²⁷⁵ Values for the longest wavelength band (in C_6H_6) are: $\text{P}(\textit{p}\text{-Tol})_3$ (440), PPh_3 (439), PCy_3 (430), $\text{P}(\textit{o}\text{-Tol})_3$ (418 nm).

IV.A. A thermochemical study ²⁷⁶ of CoCl_2L_2 complexes by differential thermal analysis indicates that more strongly electron-accepting phosphines tend to have stronger P–Co bonds; however, steric bulk weakens the bonds. Thus in eq 30 $\text{L} = \text{P}(\textit{i}\text{-Pr})_3$ requires about 16 kcal/mol less than $\text{L} = \text{PEt}_3$.

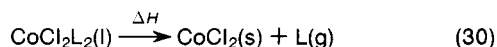

A study ²⁷⁷ of eq 31 by an accurate NMR susceptibility method [$\text{L} = \text{P}(\text{OEt})_3$, $\text{P}(\text{OEt})_2\text{Et}$, $\text{P}(\text{OEt})\text{Et}_2$, or PEt_3] has shown that *K* depends on both electronic and steric effects; the middle members of the series give the most stable five-coordinate

complexes. A similar result was obtained in a study of $\text{Ni}(\text{CN})_2[\text{P}(\text{OMe})_n\text{Me}_{3-n}]_2$ complexes. ²⁷⁸

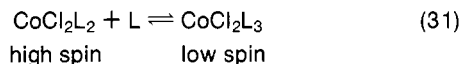

IV.D. A kinetic study of the reaction of *N*-methylaniline with *cis*- $\text{PdCl}(\text{CN}-\textit{p}\text{-C}_6\text{H}_4\text{Me})(\text{L})$ complexes to give carbene complexes (by attack of the amine on the isocyanide carbon) shows that the rates depend on both steric and electronic properties of L. ²⁷⁹ The reaction is favored by small L's which are good electron acceptors.

IV.E. Steric factors control the ligand exchange equilibria observed when $(\textit{o}\text{-Tol})\text{NiBr}(\text{PPh}_3)_2$ is treated with other phosphorus ligands, as shown by ³¹P NMR studies. ²⁸⁰

IV.G. Anderson and co-workers ²⁸¹ have shown by $^1\text{H}\{^{145}\text{Pt}\}$ INDOR measurements on solutions of *trans*- $\text{Pt}(\text{CNS})_2[\text{AsMe}_{3-n}\text{Et}_n]_2$ complexes that the coordination mode of the thiocyanate ligands is sensitive to the size of the arsines. As *n* increases from 0 to 3, the distribution changes from 69% S,S to 83% N,N bonded. The ¹⁹⁵Pt chemical shift is diagnostic for the coordination mode.

V. While most trialkylphosphines, including PEt_3 and PCy_3 , form adducts with CS_2 , $\text{P}(\textit{t}\text{-Bu})_3$ does not. ²⁸² This further emphasizes that PCy_3 acts smaller than $\text{P}(\textit{t}\text{-Bu})_3$. While most trialkyl phosphites react readily with diethyl peroxide to form pentoxy phosphoranes, ²⁸³ $\text{P}(\text{O}-\textit{t}\text{-Bu})_3$ does not react under the same conditions. ²⁸⁴

V.B. The very bulky ligands $\text{PPh}(\textit{t}\text{-Bu})_2$ and $\text{P}(\textit{t}\text{-Bu})_3$ react with H_3IrCl_6 to give the dihydrides H_2IrClL_2 , while the less bulky ligands $\text{PMe}(\textit{t}\text{-Bu})_2$ and $\text{PEt}(\textit{t}\text{-Bu})_2$ give the monohydrides HIrCl_2L_2 . ²⁸⁵ The authors propose that the larger ligands favor H over Cl because a hydride ligand causes less steric strain.

V.C. Otsuka and co-workers ²⁸⁶ have published the details of the preparations and x-ray structures of their PdL_2 and PtL_2 complexes [$\text{L} = \text{P}(\textit{t}\text{-Bu})_3$, $\text{PPh}(\textit{t}\text{-Bu})_2$, PCy_3 and $\text{P}(\textit{i}\text{-Pr})_3$]. $\text{P}(\textit{i}\text{-Pr})_3$ is small enough to allow isolation of $\text{Pt}[\text{P}(\textit{i}\text{-Pr})_3]_3$, from which one ligand can be readily removed. The still smaller $\text{P}(\text{O}-\textit{o}\text{-Tol})_3$ gives only a three-coordinate Pt complex. $\text{P}(\textit{t}\text{-Bu})_3$ is so large that even the small molecule O_2 does not react with $\text{Pd}[\text{P}(\textit{t}\text{-Bu})_3]_2$. ²⁸⁵ The authors do, however, define cone angles incorrectly. ²⁸⁶

V.D. An unusual *cis* dihydride of platinum, $\text{H}_2\text{Pt}\{[\textit{t}\text{-Bu})_2\text{PCH}_2]_2\text{C}_6\text{H}_4\}$, has been prepared with a bulky chelating diphosphine. It fails to react with HCl even on prolonged treatment. ²⁸⁷

We have been able to make the five-coordinate Fe(0) complex $\text{Fe}[\text{P}(\text{OCH}_2)_3\text{CET}]_5$ by treatment of $\text{Fe}(\text{COD})_2$ [$\text{COD} = 1,5\text{-cyclooctadiene}$] with the phosphite. ²⁸⁸ A similar reaction with the bulkier $\text{P}(\text{OPh})_3$ gives a product analyzing for " $\text{Fe}[\text{P}(\text{OPh})_3]_4$ " whose spectroscopic properties and reactions show it to be V. ²⁸⁹ Ligands of intermediate size [$\text{P}(\text{OMe})_3$, $\text{P}(\text{OEt})_3$ and $\text{P}(\text{O}-\textit{i}\text{-Pr})_3$] give (1,3-COD) FeL_3 complexes. ²⁹⁰

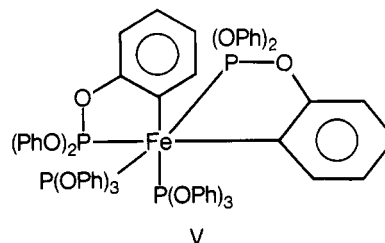

Irradiation of solutions of $\text{Fe}(\text{CO})_5$ in the presence of $\text{Ph}_2\text{P}(\text{CH}_2)_n\text{PPh}_2$ ($n = 1, 2, 3$, or 4) gave $\text{Fe}(\text{CO})_4\text{Ph}_2\text{P}(\text{CH}_2)_n\text{PPh}_2\text{Fe}(\text{CO})_4$. In the case of $n = 1$ only, however, three other products were formed: $\text{Ph}_2\text{PCH}_2\text{PPh}_2\text{Fe}(\text{CO})_4$, $\text{Ph}_2\text{PCH}_2\text{PPh}_2\text{Fe}(\text{CO})_3$, and $\text{Ph}_2\text{PCH}_2\text{PPh}_2\text{Fe}_2(\text{CO})_7$. ²⁹¹ We have found that reactions of excess $\text{Ph}_2\text{P}(\text{CH}_2)_n\text{PPh}_2$ with $(\text{COD})_2\text{Ni}$

give $\text{Ni}[\text{Ph}_2\text{P}(\text{CH}_2)_n\text{PPh}_2]_2$ for $n = 2, 3,$ or 4 but for $n = 1$ give $(\text{Ph}_2\text{PCH}_2\text{PPh}_2)_2\text{Ni}(\text{Ph}_2\text{PCH}_2\text{PPh}_2)$ in which two ligands are monodentate and one is bidentate.¹¹⁶

VI.B. Yoshikawa and co-workers²⁹² have shown that phosphorus ligand steric effects dominate the product distribution in the nickel catalyzed $4 + 2$ cycloaddition of norbornadiene to acrylonitrile, giving VI and VII. Larger ligands favor VII. In the $2 + 2$ cyclodimerization of norbornadiene, on the other hand, electronic factors dominate.²⁹³

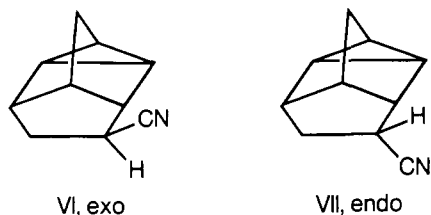

Heimbach and co-workers²⁹⁴ are using the idea of the Steric and Electronic Map to fit data on product distributions in a variety of homogeneous catalytic reactions. By expressing the surfaces as polynomial expansions in ν and θ and optimizing the coeffi-

cients by least squares, they are able to specify the percentage of electronic and steric control in each reaction.

VIII. $\text{Et}_2\text{Pt}(\text{PPh}_3)_2$ is much less stable than the metallocycle $(\text{CH}_2)_4\text{Pt}(\text{PPh}_3)_2$. This difference can be rationalized in terms of the steric constraints of the ring, which prevent the 0° Pt-C-C-H dihedral angle necessary for β -hydride elimination.²⁹⁵ The more flexible $(\text{CH}_2)_6\text{Pt}(\text{PPh}_3)_2$ complex is only marginally more stable than the dimethyl.

The isolation of $\text{M}[\text{SbAr}_3]_4$ complexes ($\text{M} = \text{Ni}, \text{Pd},$ or Pt ; $\text{Ar} = \text{Ph}$ or para-substituted phenyl) which do not dissociate extensively in solution²⁹⁶ indicates that SbAr_3 ligands have smaller effective cone angles than the corresponding PAR_3 , whose ML_4 complexes are completely dissociated in solution at ambient temperature.⁵⁸

A study of the coordination mode of BH_4^- in the series $\text{Cp}_2\text{LnBH}_4\text{THF}$ ($\text{Ln} =$ lanthanide element) shows that decreasing the effective ionic radius from 1.09 Å (samarium) to 0.98 Å (ytterbium) causes the BH_4^- to go from tridentate to bidentate.²⁹⁷

Kinetically stable MR_2 ($\text{M} = \text{Ge}, \text{Sn}, \text{Pb}$) complexes have been prepared using the very bulky $\text{R} = \text{CH}(\text{SiMe}_3)_2$ or $\text{N}(\text{SiMe}_3)_2$.²⁹⁸

XI. Appendixes

APPENDIX A. Values^a of the Electronic Parameter ν

Type of Phosphorus Ligand		ν, cm^{-1}
PX_3	$\text{P}(\text{OR})_3$	
	PR_3	
	Other	
	$\text{P}(t\text{-Bu})_3$	2056.1
	PCy_3	2056.4
	$\text{P}(\sigma\text{-C}_6\text{H}_4\text{OMe})_3$	2058.3
	$\text{P}(i\text{-Pr})_3$	2059.2
	PBu_3	2060.3
	PEt_3	2061.7
$\text{P}(\text{NMe}_2)_3$		2061.9 ^b
	PEt_2Ph	2063.7
	$\text{PPh}(\text{pip})_2$	2064.0
	PMe_3	2064.1
	PMe_2Ph	2065.3
	$\text{PPh}_2(\sigma\text{-C}_6\text{H}_4\text{OMe})$	2066.1
	PBz_3	2066.4 ^b
	$\text{P}(\sigma\text{-Tol})_3$	2066.6
	$\text{P}(\rho\text{-Tol})_3$	2066.7
	PEtPh_2	2066.7
	$\text{PMePh}_2, \text{PPh}_2\text{pip}$	2067.0
	$\text{P}(m\text{-Tol})_2$	2067.2
	PPh_2NMe_2	2067.3 ^b
	$\text{PPh}_2(2,4,6\text{-C}_6\text{H}_2\text{Me}_3)$	2067.4
	PPhBz_2	2067.6
	$\text{PPh}_2(\rho\text{-C}_6\text{H}_4\text{OMe})$	2068.2
	PPh_2Bz	2068.4
	PPh_3	2068.9
	$\text{PPh}_2(\text{CH}=\text{CH}_2)$	2069.3
	$\text{PPh}_2(\rho\text{-C}_6\text{H}_4\text{F})$	2069.5
	$\text{PPh}_2(m\text{-C}_6\text{H}_4\text{F})$	2070.0
	$\text{PPh}_2\text{CH}_2\text{CH}_2\text{Cl}$	2070.8 ^b
	$\text{P}(\rho\text{-C}_6\text{H}_4\text{F})_3$	2071.3
	$\text{P}(\text{OEt})\text{Ph}_2$	2071.6
	$\text{P}(\text{OMe})\text{Ph}_2$	2072.0
	$\text{P}(\text{O}-i\text{-Pr})_2\text{Ph}$	2072.2
	$\text{P}(\rho\text{-C}_6\text{H}_4\text{Cl})_3$	2072.8
	PPhPh_2	2073.3
	$\text{P}(\text{OBu})_2\text{Ph}$	2073.4
	$\text{P}(m\text{-C}_6\text{H}_4\text{F})_3$	2074.1
	$\text{P}(\text{OEt})_2\text{Ph}$	2074.2
	$\text{P}(\text{OPh})\text{Ph}_2$	2074.6
	$\text{PPh}_2\text{C}_6\text{F}_5$	2074.8
$\text{P}(\text{O}-i\text{-Pr})_3$		2075.9
	$\text{PPh}_2(\text{O}-\sigma\text{-C}_6\text{H}_4\text{Cl})$	2076.1
$\text{P}(\text{OEt})_3$		2076.3
	PH_2Ph	2077.0

Appendix A (Continued)

Type of Phosphorus Ligand				
PX ₃	P(OR) ₃	PR ₃	Other	ν , cm ⁻¹
		P(CH ₂ CH ₂ CN) ₃		2077.9
			P(OCH ₂) ₂ Ph	2078.7
	P(OCH ₂ CH ₂ OMe) ₃			2079.3
	P(OMe) ₃			2079.5
			P(OPh) ₂ Ph	2079.8
			PClPh ₂	2080.7
			PMe ₂ CF ₃	2080.9
PH ₃	P(O-2,4-C ₆ H ₃ Me ₂) ₃			2083.2 ^c
	P(OCH ₂ CH ₂ Cl) ₃			2084.0
	P(O- <i>p</i> -Tol) ₃ , P(O- <i>p</i> -C ₆ H ₄ OMe) ₃ }			2084.1
	P(O- <i>o</i> -Tol) ₃			
	P(O- <i>o</i> -C ₆ H ₄ - <i>i</i> -Pr) ₃			2084.6 ^b
	P(O- <i>o</i> -C ₆ H ₄ Ph) ₃			2085.0 ^b
	P(OPh) ₃			2085.3
	P(O- <i>o</i> -C ₆ H ₄ - <i>t</i> -Bu) ₃			2086.1 ^b
			P(OCH ₂) ₂ OPh	2086.5
	P(OCH ₂) ₃ CPr, P(OCH ₂) ₃ CEt			2086.8
	P(OCH ₂) ₃ CMe			2087.3
	P(OCH ₂ CH ₂ CN) ₃			2087.6
	P(O- <i>o</i> -Tol- <i>p</i> -Cl) ₃			2088.2
	P(O- <i>p</i> -C ₆ H ₄ Cl) ₃			2089.3
		P(C ₆ F ₅) ₃		2090.9
	P(OCH ₂ CCl ₃) ₃			2091.7
			PCl ₂ Ph	2092.1
	P(O- <i>p</i> -C ₆ H ₄ CN) ₃			2092.8
PCl ₃				2097.0
PF ₃				2110.8

$$\text{Substituent Contributions to } \nu \text{ for } \text{PX}_1\text{X}_2\text{X}_3: \nu = 2056.1 + \sum_{i=1}^3 \chi_i$$

Substituent X _i	χ_i	Substituent X _i	χ_i
<i>t</i> -Bu	0.0	<i>p</i> -C ₆ H ₄ OMe	3.4
Cy	0.1	<i>o</i> -Tol, <i>p</i> -Tol, Bz	3.5
<i>o</i> -C ₆ H ₄ OMe	0.9	<i>m</i> -Tol	3.7
<i>i</i> -Pr	1.0	Ph	4.3
<i>i</i> -Bu	1.2 est	CH=CH ₂	4.5
Bu	1.4	<i>p</i> -C ₆ H ₄ F	5.0
Et	1.8	<i>p</i> -C ₆ H ₄ Cl	5.6
NMe ₂	1.9	<i>m</i> -C ₆ H ₄ F	6.0
piperidyl	2.0	CH ₂ CH ₂ Cl	6.1 ^b
Me	2.6	<i>O</i> - <i>i</i> -Pr	6.3
2,4,6-C ₆ H ₂ Me ₃	2.7	OBu	6.5
OEt	6.8	(OCH ₂) ₂ /2	9.8
CH ₂ CH ₂ CN	7.3	<i>O</i> - <i>o</i> -C ₆ H ₄ - <i>t</i> -Bu	10.0 ^b
OMe, OCH ₂ CH=CH ₂ , OCH ₂ CH ₂ OMe	7.7	OCH ₂ CH ₂ CN	10.5
H	8.3	<i>O</i> - <i>o</i> -Tol- <i>p</i> -Cl	11.1
<i>O</i> -2,4-C ₆ H ₃ Me ₂	9.0	C ₆ F ₅	11.2
OCH ₂ CH ₂ Cl, <i>O</i> - <i>o</i> -Tol, <i>O</i> - <i>p</i> -Tol, <i>O</i> - <i>p</i> -C ₆ H ₄ OMe	9.3	<i>O</i> - <i>o</i> -C ₆ H ₄ Cl	11.4
<i>O</i> - <i>o</i> -C ₆ H ₄ - <i>i</i> -Pr	9.5 ^b	OCH ₂ CCl ₃	11.9
<i>O</i> - <i>o</i> -C ₆ H ₄ - <i>t</i> -Bu	9.6 ^b	<i>O</i> - <i>p</i> -C ₆ H ₄ CN	12.2
OPh	9.7	Cl	14.8
		F	18.2
		CF ₃	19.6

^a $\nu_{\text{CO}}(\text{A}_1)$ of Ni(CO)₃L in CH₂Cl₂ from ref 1 unless noted otherwise. pip = piperidine. ^b Previously unpublished value. ^c This value for PH₃ was estimated from extrapolation of values for PH_{3-n}Ph_n (*n* = 1 to 3).

APPENDIX B. Values^a of the Ligand Cone Angle θ

Type of Phosphorus Ligand				
PX ₃	P(OR) ₃	PR ₃	Other	θ , deg
PH ₃				87
	P(OCH ₂) ₃ CR'		PH ₂ Ph ^{b,c}	101
PF ₃				104
	P(OCH) ₃ (CH ₂) ₃			106
	P(OMe) ₃		Me ₂ PCH ₂ CH ₂ PMe ₂ ^d	107

APPENDIX B (Continued)

Type of Phosphorus Ligand					Θ , deg
PX ₃	P(OR) ₃	PR ₃	Other		
P(NCH ₂ CH ₂) ₃	P(OEt) ₃ P(OCH ₂ CH ₂ Cl) ₃	P(CH ₂ O) ₃ CR' ^b	Et ₂ PCH ₂ CH ₂ PEt ₂ ^{b,d} P(OMe) ₂ Ph, P(OMe) ₂ Et P(OEt) ₂ Ph ^{b,c}	108	
				109	
				110	
	P(OCH ₂ CCl ₂) ₃ ^e	PMe ₃	Ph ₂ PCH ₂ PPh ₂ ^{b,d} PMe ₂ Ph ^{b,c}	114	
				115	
	PCl ₃	P(OPh) ₃ , P(O- <i>p</i> -Tol) ₃ ^f P(O- <i>i</i> -Pr) ₃ ^f	PMe ₂ CF ₃ ^b Ph ₂ PCH ₂ CH ₂ PPh ₂ ^{b,d} Ph ₂ P(CH ₂) ₃ PPh ₂ ^{b,d} PHPh ₂ ^b	116	
				118	
				121	
				122	
				124	
PBr ₃	P(O- <i>o</i> -Tol) ₃ ^f	PEt ₃ , PBu ₃ , ^g PPr ₃ , P(CH ₂ CH ₂ CN) ₃ } P(CF ₃) ₃ P(<i>i</i> -Bu) ₃ ^b PPh ₃ , P(<i>p</i> -Tol) ₃ , P(<i>m</i> -C ₆ H ₄ F) ₃	POMePh ₂ ^f POEtPh ₂ ^b PMePh ₂ , ^f PEt ₂ Ph ^b PEtPh ₂ ^b Cy ₂ PCH ₂ CH ₂ PCy ₂ ^{b,d}	125	
				127	
				128	
				130	
				131	
				132	
				133	
				136	
				137	
				140	
P(NMe ₂) ₃	P(O- <i>o</i> -C ₆ H ₄ - <i>i</i> -Pr) ₃ ^e P(O- <i>o</i> -C ₆ H ₄ Ph) ₃ ^e P(O- <i>t</i> -Bu) ₃ P(O- <i>o</i> -C ₆ H ₄ - <i>t</i> -Bu) ₃ ^h P(O-2,6-C ₆ H ₃ Me ₂) ₃ ^e	P(<i>i</i> -Pr) ₃ , P(<i>sec</i> -Bu) ₃ ^b PBz ₃ ^e PCy ₃ ^h P(neopentyl) P(<i>t</i> -Bu) ₃ P(C ₆ F ₅) ₃ P(<i>o</i> -Tol) ₃ P(mesityl) ₃ ^b	PPh ₂ (<i>i</i> -Pr) ^b PPh ₂ (<i>t</i> -Bu) ^b PPh ₂ C ₆ F ₅ ^b PPh(<i>t</i> -Bu) ₂ ^b	141	
				142	
				143	
				145	
				148	
				150	
				152	
				157	
				158	
				160	
165					
170					
172					
175					
~180					
182					
184					
190					
194					
212					

^a From model measurements in ref 2 unless noted otherwise. ^b Previously unpublished value. ^c Based on a "sideways" phenyl ring with $\theta/2 = 65^\circ$. ^d Values given are for half of the chelate assuming PMP angles in $M[R_2P(CH_2)_nPR_2]$ of 74, 85, or 90° for $n = 1, 2, \text{ or } 3$, respectively. ^e Reference 250. ^f Reference 9. ^g Increased 2° from the value in ref 2 because PBu₃ should not be smaller than PEt₃. ^h Value based in part on the degree of substitution of CO from Ni(CO)₄ (Figure 9).

APPENDIX C. Cone Angles^a for Ligands not Bound by a Group 5 Atom

X ^b	R	Other	Cone angle, deg	X ^b	R	Other	Cone angle, deg
H	Me	CO, CN, N ₂ , NO COCH ₃	75	Br	Ph ^d	CH ₂ CMe ₃ ^e <i>t</i> -Bu	105
F			90	I			107
			92				114
			~95 ^c				120
Cl	Et		100				126
	CH ₂ Ph		102			Cp	136 ^f
			104				

^a Based on a metal covalent radius of 1.32 Å. ^b Calculated using the covalent and van der Waals radii (Å) of the CPK models: H (0.33, 1.00), F (0.57, 1.35), Cl (0.99, 1.80), Br (1.14, 1.95), and I (1.35, 2.15). ^c The covalent and van der Waals radii of the CPK -C≡ atom lead to a cone angle of 113°. This must be an overestimate since group 6 M(CO)₆ complexes are very stable. A Θ for CO slightly larger than 90° is suggested by the angles in Mn₂(CO)₁₀ (Table VIII) and HMn(CO)₅ (structure 102). ^d The maximum and minimum half angles are 65 and 40°. ^e Essentially the same cone angle was obtained for CH₂SiMe₃, assuming a 0.96 Å covalent radius for Si. ^f An M-Cp distance of 2.03 Å was assumed, as reported for CpWCl(CF₃C₂CF₃)₂ by J. L. Davidson, M. Green, D. W. A. Sharp, F. G. A. Stone, and A. J. Welch, *Chem. Commun.*, 706 (1974).

Acknowledgments. I am indebted to several people for helpful discussions and for providing me with results prior to publication:

M. C. Baird, R. Baker, P. Binger, T. L. Brown, J. A. Connor, A. D. English, L. W. Gossler, T. A. Herskovitz, C. S. Kraihanzel, M.

Laing, L. G. Marzilli, P. Meakin, A. Musco, J. H. Nelson, J. F. Nixon, A. J. Poë, R. R. Schrock, B. L. Shaw, M. A. Weiner, and J. G. Verkade. I would also like to acknowledge the great effort of Ms. Kay Burton in typing the manuscript and the patience of my wife Ann during its preparation.

XII. References

- (1) C. A. Tolman, *J. Am. Chem. Soc.*, **92**, 2953 (1970).
- (2) C. A. Tolman, *J. Am. Chem. Soc.*, **92**, 2956 (1970).
- (3) CPK atomic models (scale 1.25 cm/Å) are available from the Ealing Corp., 22 Pleasant St., South Natick, Mass.
- (4) A. Pidcock, "Transition Metal Complexes of Phosphorus, Arsenic, and Antimony Ligands", C. A. McAuliffe, Ed., Wiley, New York, N.Y., 1973, p 25.
- (5) H. C. Brown, "Boranes in Organic Chemistry", Cornell University Press, Ithaca, N.Y., 1972.
- (6) R. W. Taft, in "Steric Effects in Organic Chemistry", M. S. Newman, Ed., Wiley, New York, N.Y., 1956, Chapter 13.
- (7) H. A. Bent, *Chem. Rev.*, **61**, 275 (1961).
- (8) W. Strohmeier and F. J. Müller, *Chem. Ber.*, **100**, 2812 (1967).
- (9) C. A. Tolman, W. C. Seidel, and L. W. Gosser, *J. Am. Chem. Soc.*, **96**, 53 (1974).
- (10) IR spectra (2400–1800 cm^{-1}) in a 0.1-mm cell are run on a solution of 0.025 mmol $\text{Ni}(\text{CO})_4$ and 0.2 mmol L in 0.5 cm^3 toluene before and after sealing in a tube (5 mm o.d. by 15 cm long) and heating over the weekend at 100 °C. In cases where a ligand coordinates so poorly that unreacted $\text{Ni}(\text{CO})_4$ remains 5 min after adding L, the DS is estimated from the room-temperature spectrum; heating at 100 °C often decomposes the $\text{Ni}(\text{CO})_4$ to metallic Ni and CO. A DS of 0.5 implies a 50:50 mixture of $\text{Ni}(\text{CO})_4$ and $\text{Ni}(\text{CO})_3\text{L}$.
- (11) L. J. Guggenberger, *J. Organomet. Chem.*, **81**, 271 (1974).
- (12) D. E. C. Corbridge, "The Structural Chemistry of Phosphorus", Elsevier, Amsterdam, 1974.
- (13) D. A. Allison, J. Clardy, and J. G. Verkade, *Inorg. Chem.*, **11**, 2804 (1972).
- (14) H. J. Plastas, J. M. Stewart, and S. O. Grim, *Inorg. Chem.*, **12**, 265 (1973).
- (15) A. D. U. Hardy and G. A. Sim, *J. Chem. Soc., Dalton Trans.*, 1900 (1972).
- (16) M. A. Bush, A. D. U. Hardy, Lj. Manojlović-Muir, and G. A. Sim, *J. Chem. Soc. A*, 1003 (1971).
- (17) M. J. Barrow and G. A. Sim, *J. Chem. Soc., Dalton Trans.*, 291 (1975).
- (18) I. Macleod, L. Manojlović-Muir, D. Millington, K. W. Muir, D. W. A. Sharp, and R. Walker, *J. Organomet. Chem.*, **97**, C7 (1975).
- (19) L. Manojlović-Muir, D. Millington, K. W. Muir, D. W. A. Sharp, W. E. Hill, J. V. Quagliano, and L. M. Vallarino, *Chem. Commun.*, 999 (1974).
- (20) G. J. Palenik, M. Mathew, W. L. Steffen, and G. Beran, *J. Am. Chem. Soc.*, **97**, 1059 (1975). Electronic effects may be important in determining linkage isomers in other systems. See J. E. Huheey and S. O. Grim, *Inorg. Nucl. Chem. Lett.*, **10**, 973 (1974).
- (21) N. W. Alcock and P. G. Leviston, *J. Chem. Soc., Dalton Trans.*, 1834 (1974).
- (22) A. Immirzi, A. Musco, G. Carturan, and U. Belluco, *Inorg. Chim. Acta*, **12**, L13 (1975).
- (23) A. Immirzi, A. Musco, P. Zambelli, and G. Carturan, *Inorg. Chim. Acta*, **13**, L23 (1975).
- (24) E. C. Alyea, A. Costin, G. Ferguson, G. T. Fey, R. G. Goel, and R. J. Restivo, *J. Chem. Soc., Dalton Trans.*, 1294 (1975).
- (25) R. P. Taylor, D. H. Templeton, A. Zalkin, and W. D. Horrocks, *Inorg. Chem.*, **7**, 2629 (1968).
- (26) P. B. Hitchcock, M. McPartlin, and R. Mason, *Chem. Commun.*, 1367 (1969).
- (27) C. A. Tolman, P. Z. Meakin, D. L. Lindner, and J. P. Jesson, *J. Am. Chem. Soc.*, **96**, 2762 (1974).
- (28) G. G. Messmer, E. L. Amma, and J. A. Ibers, *Inorg. Chem.*, **6**, 725 (1967).
- (29) G. W. Bushnell, A. Pidcock, and M. A. R. Smith, *J. Chem. Soc., Dalton Trans.*, 572 (1975).
- (30) (a) G. W. Clark, B. W. Skelton, and T. N. Waters, *J. Organomet. Chem.*, **85**, 375 (1975); (b) M. Laing, M. J. Nolte, and E. Singleton, *Chem. Commun.*, 660 (1975).
- (31) B. A. Frenz and J. A. Ibers in "Transition Metal Hydrides", E. L. Muetterties, Ed., Marcel Dekker, New York, N.Y., 1971, Chapter 3.
- (32) M. L. Schneider and H. M. M. Shearer, *J. Chem. Soc., Dalton Trans.*, 354 (1973).
- (33) R. W. Baker and P. Pauling, *Chem. Commun.*, 1495 (1969).
- (34) J. Sinclair and J. F. Nixon, private communication from Nixon.
- (35) (a) C. A. Ghilardi, S. Midollini, and L. Sacconi, *Inorg. Chem.*, **14**, 1790 (1975); (b) M. Laing, T. Ashworth, P. Sommerville, E. Singleton, and R. Reimann, *Chem. Commun.*, 1251 (1972).
- (36) References 37–40 are recommended for the interested reader.
- (37) M. M. Crutchfield, C. H. Dungan, J. H. Letcher, V. Mark, and J. R. Van Wazer, "³¹P Nuclear Magnetic Resonance", *Top. Phosphorus Chem.*, **5** (1967).
- (38) J. F. Nixon and A. Pidcock, "Phosphorus-31 Nuclear Magnetic Resonance Spectra of Coordination Compounds", *Annu. Rev. NMR Spectrosc.*, **2**, 345–422 (1969).
- (39) E. G. Finer and R. K. Harris, "Spin-Spin Coupling between Phosphorus Nuclei", *Prog. Nucl. Magn. Reson. Spectrosc.*, 61–118 (1970).
- (40) G. Mavel, "NMR Studies of Phosphorus Compounds", *Annu. Rep. NMR Spectrosc.*, **5B**, 1 (1973).
- (41) S. O. Grim, W. McFarlane, and E. F. Davidoff, *J. Org. Chem.*, **32**, 781 (1967).
- (42) L. J. Vande Griend, J. G. Verkade, C. Jongsma, and F. Bickelhaupt, *Phosphorus*, in press.
- (43) C. Jongsma, J. P. De Kleijn, and F. Bickelhaupt, *Tetrahedron*, **30**, 3465 (1974).
- (44) M. Y. Darensbourg and D. Daigle, *Inorg. Chem.*, **14**, 1217 (1975).
- (45) Reference 37, p 183.
- (46) J. G. Verkade, *Coord. Chem. Rev.*, **9**, 1 (1972), and private communication.
- (47) V. S. Mastryukov, L. V. Vilkov, and P. A. Akishin, *Acta Crystallogr., Suppl.*, **16**, 128 (1963), reported an approximate angle of 104° in trivinyl phosphite by electron diffraction.
- (48) See ref 37, Figure 2.2 on p 117, and the discussion beginning on p 80.
- (49) D. G. Gorenstein, *J. Am. Chem. Soc.*, **97**, 898 (1975).
- (50) B. E. Mann, C. Masters, and B. L. Shaw, *J. Chem. Soc. A*, 1104 (1971).
- (51) P. E. Garrou, *Inorg. Chem.*, **14**, 1435 (1975).
- (52) R. B. King and J. C. Cloyd, Jr., *Inorg. Chem.*, **14**, 1550 (1975).
- (53) B. E. Mann, *J. Chem. Soc., Perkin Trans. 2*, 30 (1972).
- (54) S. O. Grim, D. A. Wheatland, and W. McFarlane, *J. Am. Chem. Soc.*, **89**, 5573 (1967).
- (55) G. G. Mather, A. Pidcock, and G. J. N. Rapsey, *J. Chem. Soc., Dalton Trans.*, 2095 (1973).
- (56) C. A. Tolman and L. E. Manzer, to be published.
- (57) F. B. Ogilvie, J. M. Jenkins, and J. G. Verkade, *J. Am. Chem. Soc.*, **92**, 1916 (1970).
- (58) C. A. Tolman, W. C. Seidel, and D. H. Gerlach, *J. Am. Chem. Soc.*, **94**, 2669 (1972).
- (59) J. Chatt, R. Mason, and D. W. Meek, *J. Am. Chem. Soc.*, **97**, 3826 (1975).
- (60) P. S. Braterman, R. J. Cross, L. Manojlović-Muir, K. W. Muir, and G. B. Young, *J. Organomet. Chem.*, **84**, C40 (1975).
- (61) W. C. Trogler and L. G. Marzilli, *J. Am. Chem. Soc.*, **96**, 7589 (1974).
- (62) W. C. Trogler and L. G. Marzilli, *Inorg. Chem.*, **14**, 2942 (1975).
- (63) J. A. Bowden and R. Colton, *Aust. J. Chem.*, **24**, 2471 (1971).
- (64) Y. Okamoto and K. I. Lee, *J. Am. Chem. Soc.*, **97**, 4015 (1975).
- (65) M. Matsumoto, H. Yoshioka, K. Nakatsu, T. Yoshida, and S. Otsuka, *J. Am. Chem. Soc.*, **96**, 3323 (1974).
- (66) K. Stanley and M. C. Baird, *Inorg. Nucl. Chem. Lett.*, **10**, 1111 (1974); *J. Am. Chem. Soc.*, **97**, 4292 (1975).
- (67) B. L. Shaw, *J. Organomet. Chem.*, **94**, 251 (1975).
- (68) G. K. McEwen, C. J. Rix, M. F. Traynor, and J. G. Verkade, *Inorg. Chem.*, **13**, 2800 (1974).
- (69) A. R. Schoenberg and W. P. Anderson, *Inorg. Chem.*, **13**, 465 (1974).
- (70) D. W. Allen, F. G. Mann, I. T. Millar, H. M. Powell, and D. Watkin, *Chem. Commun.*, 1004 (1969).
- (71) (a) G. R. Dobson, I. W. Stolz, and R. K. Sheline, *Adv. Inorg. Chem. Radiochem.*, **8**, 1 (1966); cf. p 70; (b) M. A. Bennett, R. J. H. Clark, and A. D. J. Goodwin, *Inorg. Chem.*, **6**, 1625 (1967).
- (72) G. Giacometti and A. Turco, *J. Inorg. Nucl. Chem.*, **15**, 242 (1960).
- (73) L. Que, Jr., and L. H. Pignolet, *Inorg. Chem.*, **12**, 156 (1973).
- (74) (a) G. Giacometti, V. Scatturin, and A. Turco, *Gazz. Chim. Ital.*, **88**, 434 (1958); (b) A. Turco, V. Scatturin, and G. Giacometti, *Nature (London)*, **183**, 601 (1959).
- (75) J. A. Connor and P. I. Riley, *Inorg. Chim. Acta*, **15**, 197 (1975).
- (76) N. A. Bailey and R. Mason, *J. Chem. Soc. A*, 2594 (1968).
- (77) L. M. Venanzi, *J. Chem. Soc.*, 719 (1958).
- (78) J. Chatt and B. L. Shaw, *J. Chem. Soc.*, 705, 4020 (1959).
- (79) E. C. Alyea, G. T. Fey, and R. G. Goel, *J. Coord. Chem.*, **5**, 143 (1976).
- (80) F. A. Cotton, O. D. Faut, and D. M. L. Goodgame, *J. Am. Chem. Soc.*, **83**, 344 (1961).
- (81) (a) C. W. Smith, G. W. VanLoon, and M. C. Baird, *J. Coord. Chem.*, in press; (b) *Can. J. Chem.*, **54**, 1875 (1976).
- (82) (a) F. L. Wimmer, M. R. Snow, and A. M. Bond, *Inorg. Chem.*, **13**, 1617 (1974); (b) A. M. Bond, R. Colton, and J. J. Jackowski, *ibid.*, **14**, 274 (1975).
- (83) (a) A. Musco, W. Kuran, A. Silvani, and W. Anker, *Chem. Commun.*, 938 (1973); (b) W. Kuran and A. Musco, *Inorg. Chim. Acta*, **12**, 187 (1975).
- (84) B. E. Mann and A. Musco, *J. Chem. Soc., Dalton Trans.*, 1673 (1975).
- (85) S. J. Lippard and J. J. Mayerle, *Inorg. Chem.*, **11**, 753 (1972).
- (86) K. W. Barnett and T. G. Pollmann, *J. Organomet. Chem.*, **69**, 413 (1974).
- (87) E. L. Muetterties and F. J. Hirsekorn, *J. Am. Chem. Soc.*, **96**, 7920 (1974).
- (88) P. Rigo and A. Turco, *Coord. Chem. Rev.*, **8**, 175 (1972).
- (89) C. A. Tolman and E. J. Lukosius, *Inorg. Chem.*, in press.
- (90) J. D. Druliner, A. D. English, J. P. Jesson, P. Meakin, and C. A. Tolman, *J. Am. Chem. Soc.*, **98**, 2156 (1976).
- (91) P. R. Hoffman and K. G. Caulton, *J. Am. Chem. Soc.*, **97**, 4221 (1975).
- (92) J. A. Connor and P. I. Riley, *J. Organomet. Chem.*, **94**, 55 (1975).
- (93) T. Herskovitz, private communication.
- (94) M. Bressan, B. Corain, P. Rigo, and A. Turco, *Inorg. Chem.*, **9**, 1733 (1970).
- (95) (a) T. Boschi, P. Rigo, C. Pecile, and A. Turco, *Gazz. Chim. Ital.*, **97**, 1391 (1967); (b) P. Rigo, G. Guastalla, and A. Turco, *Inorg. Chem.*, **8**, 375 (1969).
- (96) K. Henrick and S. B. Wild, *J. Chem. Soc., Dalton Trans.*, 2500 (1974).
- (97) M. Bressan and P. Rigo, *Inorg. Chem.*, **14**, 2286 (1975).
- (98) A. J. Drakesmith and R. Whyman, *J. Chem. Soc., Dalton Trans.*, 362 (1973).
- (99) R. Whyman, *J. Organomet. Chem.*, **94**, 303 (1975).
- (100) P. W. Armit, A. S. F. Boyd, and T. A. Stephenson, *J. Chem. Soc., Dalton Trans.*, 1663 (1975).
- (101) A. J. Poe, XVth Annual Conference on Coordination Chemistry, Dublin, Ireland, 1974.
- (102) H. F. Klein, *Angew. Chem., Int. Ed. Engl.*, **10**, 343 (1971).
- (103) J. Chatt, F. A. Hart, and D. T. Rosevear, *J. Chem. Soc.*, 5504 (1961).

- (104) G. Speier and L. Marko, *Inorg. Chim. Acta*, **3**, 126 (1969).
- (105) F. A. Cotton and G. Wilkinson, "Advanced Inorganic Chemistry", 3rd ed. Interscience, New York, N.Y., 1972, p 829.
- (106) J. Chatt and H. R. Watson, *J. Chem. Soc.*, 2545 (1962).
- (107) See, for example, D. Griller, L. R. C. Barclay, and K. U. Ingold, *J. Am. Chem. Soc.*, **97**, 6151 (1975), and references therein.
- (108) (a) A. J. Poë and M. V. Twigg, *J. Organomet. Chem.*, **50**, C39 (1973); (b) *J. Chem. Soc., Dalton Trans.*, 1860 (1974).
- (109) M. L. H. Green, H. Munakata, and T. Saito, *J. Chem. Soc. A*, 469 (1971).
- (110) G. R. Dobson and J. R. Paxson, *J. Am. Chem. Soc.*, **95**, 5925 (1973).
- (111) R. J. Angelici and R. W. Brink, *Inorg. Chem.*, **12**, 1067 (1973).
- (112) P. G. Douglas and B. L. Shaw, *J. Chem. Soc. A*, 1556 (1970).
- (113) Y. Nakamura, K. I. Maruya, and T. Mizoroki, *J. Organomet. Chem.*, **104**, C5 (1976).
- (114) H. Fischer, E. O. Fischer, and H. Werner, *J. Organomet. Chem.*, **73**, 331 (1974).
- (115) D. H. Gerlach, W. G. Peet, and E. L. Muetterties, *J. Am. Chem. Soc.*, **94**, 4545 (1972).
- (116) A. D. English and C. A. Tolman, to be published.
- (117) R. H. Reimann and E. Singleton, *J. Organomet. Chem.*, **59**, 309 (1973).
- (118) R. H. Reimann and E. Singleton, *J. Chem. Soc., Dalton Trans.*, 841 (1973); *J. Organomet. Chem.*, **44**, C18 (1972).
- (119) C. A. Tolman, D. H. Gerlach, J. P. Jesson, and R. A. Schunn, *J. Organomet. Chem.*, **68**, C23 (1974).
- (120) P. W. Jolly, K. Jonas, C. Krüger, and Y.-H. Tsay, *J. Organomet. Chem.*, **33**, 109 (1971).
- (121) C. A. Tolman, *Inorg. Chem.*, **10**, 1540 (1971).
- (122) L. W. Gosser, *Inorg. Chem.*, **15**, 1348 (1976).
- (123) C. A. Tolman, unpublished results.
- (124) L. J. Guggenberger, *Inorg. Chem.*, **12**, 499 (1973).
- (125) C. A. Tolman, *J. Am. Chem. Soc.*, **96**, 2780 (1974).
- (126) J. Nasielski, M. Vermeulen, and P. Leempoel, *J. Organomet. Chem.*, **102**, 195 (1975).
- (127) J. Halpern, *Acc. Chem. Res.*, **3**, 386 (1970).
- (128) C. A. Tolman, *Chem. Soc. Rev.*, **1**, 337 (1972).
- (129) J. Halpern and P. F. Phelan, *J. Am. Chem. Soc.*, **94**, 1881 (1972).
- (130) S. G. Clarkson and F. Basolo, *Inorg. Chem.*, **12**, 1528 (1973).
- (131) R. Ugo, A. Pasini, A. Fusi, and S. Cenini, *J. Am. Chem. Soc.*, **94**, 7364 (1972).
- (132) R. Brady, W. H. DeCamp, B. R. Flynn, M. L. Schneider, J. D. Scott, L. Vaska, and M. F. Werneke, *Inorg. Chem.*, **14**, 2669 (1975).
- (133) M. Pankowski and M. Bigorgne, *J. Organomet. Chem.*, **30**, 227 (1971).
- (134) B. L. Shaw and R. E. Stainbank, *J. Chem. Soc., Dalton Trans.*, 223 (1972).
- (135) H. D. Empsall, E. M. Hyde, C. E. Jones, and B. L. Shaw, *J. Chem. Soc., Dalton Trans.*, 1980 (1974).
- (136) R. J. McKinney, R. Hoxmeier, and H. D. Kaesz, *J. Am. Chem. Soc.*, **97**, 3059 (1975).
- (137) (a) C. E. Jones, B. L. Shaw, and B. L. Turtle, *J. Chem. Soc., Dalton Trans.*, 992 (1974); (b) J. M. Duff, B. E. Mann, B. L. Shaw, and L. Turtle, *J. Chem. Soc., Dalton Trans.*, 139 (1974), and references therein.
- (138) A. A. Kiffen, C. Masters, and L. Raynand, *J. Chem. Soc., Dalton Trans.*, 853 (1975).
- (139) C. A. Tolman, W. M. Riggs, W. J. Linn, C. M. King, and R. C. Wendt, *Inorg. Chem.*, **12**, 2770 (1973).
- (140) B. Corain and G. Favero, *J. Chem. Soc., Dalton Trans.*, 283 (1975).
- (141) C. A. Tolman, unpublished results.
- (142) J. Chatt and R. G. Wilkins, *J. Chem. Soc.*, 525 (1956).
- (143) A. W. Verstuyft and J. H. Nelson, *Inorg. Chem.*, **14**, 1501 (1975).
- (144) N. Ahmad, E. W. Ainscough, T. A. James, and S. D. Robinson, *J. Chem. Soc., Dalton Trans.*, 1148 (1973).
- (145) D. G. Cooper and J. Powell, *Can. J. Chem.*, **51**, 1634 (1973).
- (146) P. K. Maples and C. S. Kraihanzel, *J. Am. Chem. Soc.*, **90**, 6645 (1968).
- (147) C. S. Kraihanzel and P. K. Maples, *J. Organomet. Chem.*, **117**, 159 (1976).
- (148) G. K. N. Reddy and B. R. Ramesh, *J. Organomet. Chem.*, **67**, 443 (1974), and references therein.
- (149) D. J. Thornhill and A. R. Manning, *J. Chem. Soc., Dalton Trans.*, 6 (1974).
- (150) L. H. Pignolet, W. D. Horrocks, Jr., and R. H. Holm, *J. Am. Chem. Soc.*, **92**, 1855 (1970), and references therein.
- (151) R. G. Hayter and F. S. Humiec, *Inorg. Chem.*, **4**, 1701 (1965).
- (152) B. T. Kilbourn, H. M. Powell, and J. A. C. Darbyshire, *Proc. Chem. Soc., London*, 207 (1963).
- (153) L. Que, Jr., and L. H. Pignolet, *Inorg. Chem.*, **12**, 156 (1973).
- (154) P. L. Bellon, V. Albano, V. D. Bianco, F. Pompa, and V. Scaturin, *Ric. Sci.*, **33**, 1213 (1963).
- (155) G. N. LaMar and E. O. Sherman, *J. Am. Chem. Soc.*, **92**, 2691 (1970).
- (156) J. J. McGarvey and J. Wilson, *J. Am. Chem. Soc.*, **97**, 2531 (1975).
- (157) G. R. Van Hecke and W. D. Horrocks, Jr., *Inorg. Chem.*, **5**, 1968 (1966).
- (158) S. O. Grim, J. DelGaudio, R. P. Molenda, C. A. Tolman, and J. P. Jesson, *J. Am. Chem. Soc.*, **96**, 3416 (1974).
- (159) R. D. Bertrand, D. A. Allison, and J. G. Verkade, *J. Am. Chem. Soc.*, **92**, 71 (1970).
- (160) S. Jacobson, Y. S. Wong, P. C. Chieh, and A. J. Carty, *Chem. Commun.*, 520 (1974); A. J. Carty, P. C. Chieh, N. J. Taylor, and Y. S. Wong, *J. Chem. Soc., Dalton Trans.*, 572 (1976).
- (161) M. A. Bennett and R. Charles, *J. Am. Chem. Soc.*, **94**, 666 (1972).
- (162) S. Otsuka, A. Nakamura, T. Kano, and K. Tani, *J. Am. Chem. Soc.*, **93**, 4301 (1971).
- (163) M. R. Churchill, B. G. Deboer, and S. J. Mendak, *Inorg. Chem.*, **14**, 2041 (1975).
- (164) M. D. Gordon and L. D. Quin, *Chem. Commun.*, 35 (1975).
- (165) S. I. Featherman and L. D. Quin, *J. Am. Chem. Soc.*, **97**, 4349 (1975).
- (166) J. P. Jesson and P. Meakin, *J. Am. Chem. Soc.*, **96**, 5760 (1974).
- (167) P. Meakin, E. L. Muetterties, and J. P. Jesson, *J. Am. Chem. Soc.*, **95**, 75 (1973).
- (168) P. Kalck, R. Pince, R. Poilblanc, and J. Roussel, *J. Organomet. Chem.*, **24**, 445 (1970).
- (169) B. F. G. Johnson and J. A. Segal, *J. Chem. Soc., Dalton Trans.*, 981 (1974).
- (170) C. H. Bushweller and M. Z. Lourandos, *Inorg. Chem.*, **13**, 2514 (1974).
- (171) J. A. Brunelle, C. H. Bushweller, and A. D. English, *J. Phys. Chem.*, **80**, 2598 (1976).
- (172) B. E. Mann, C. Masters, B. L. Shaw, and R. E. Stainbank, *Chem. Commun.*, 1103 (1971).
- (173) A. Bright, B. E. Mann, C. Masters, B. L. Shaw, R. M. Slade, and R. E. Stainbank, *J. Chem. Soc. A*, 1826 (1971).
- (174) T. G. Attig and H. C. Clark, *J. Organomet. Chem.*, **94**, C49 (1975).
- (175) B. F. G. Johnson and J. A. Segal, *J. Chem. Soc., Dalton Trans.*, 981 (1974).
- (176) L. S. Chia, W. R. Cullen, M. Franklin, and A. R. Manning, *Inorg. Chem.*, **14**, 2521 (1975).
- (177) R. B. King, *Inorg. Chem.*, **2**, 936 (1963).
- (178) F. G. Moers and J. G. A. Reuvers, *Recl. Trav. Chim. Pays-Bas*, **93**, 246 (1974).
- (179) R. Mathieu, M. Lenzi, and R. Poilblanc, *Inorg. Chem.*, **9**, 2030 (1970).
- (180) A. R. Schoenberg and W. P. Anderson, *Inorg. Chem.*, **11**, 85 (1972).
- (181) K. Jonas, *J. Organomet. Chem.*, **78**, 273 (1974).
- (182) D. J. Brauer and C. Krüger, *J. Organomet. Chem.*, **77**, 423 (1974).
- (183) M. Aresta, C. F. Nobile, V. G. Albano, E. Forni, and M. Manassero, *Chem. Commun.*, 636 (1975).
- (184) M. L. H. Green and W. E. Silverthorn, *J. Chem. Soc., Dalton Trans.*, 2164 (1974); 301 (1973).
- (185) H. L. M. Van Gaal, F. G. Moers, and J. J. Steggerda, *J. Organomet. Chem.*, **65**, C43 (1974).
- (186) M. L. H. Green, T. Saito, and P. J. Tanfield, *J. Chem. Soc. A*, 152 (1971).
- (187) M. L. H. Green, H. Munakata, and T. Saito, *J. Chem. Soc. A*, 469 (1971).
- (188) B. L. Shaw and M. F. Uttley, *Chem. Commun.*, 918 (1974).
- (189) K. Kudo, M. Hidai, and Y. Uchida, *J. Organomet. Chem.*, **56**, 413 (1973).
- (190) L. W. Gosser and C. A. Tolman, *Inorg. Chem.*, **9**, 2350 (1970).
- (191) C. A. Tolman, W. C. Seidel, and D. H. Gerlach, *J. Am. Chem. Soc.*, **94**, 2669 (1972).
- (192) M. Green, J. A. Howard, J. L. Spencer, and F. G. A. Stone, *Chem. Commun.*, 3 (1975).
- (193) A. Immirzi and A. Musco, *Chem. Commun.*, 400 (1974).
- (194) R. G. Pearson, W. Louw, and J. Rajaram, *Inorg. Chim. Acta*, **9**, 251 (1974).
- (195) M. Bressan and P. Rigo, *Inorg. Chem.*, **14**, 38 (1975).
- (196) H. F. Klein and H. H. Karsch, *Inorg. Chem.*, **14**, 473 (1975).
- (197) B. L. Shaw and R. E. Stainbank, *J. Chem. Soc., Dalton Trans.*, 2108 (1972).
- (198) F. G. Moers and J. P. Langhout, *Recl. Trav. Chim. Pays-Bas*, **91**, 591 (1972).
- (199) L. Vaska and J. W. DiLuzio, *J. Am. Chem. Soc.*, **83**, 1262 (1961).
- (200) J. Chatt, C. D. Falk, G. J. Leigh, and R. J. Paske, *J. Chem. Soc. A*, 2288 (1969).
- (201) A. Ducruix, H. Felkin, C. Pascard, and G. K. Turner, *Chem. Commun.*, 615 (1975).
- (202) Th. Kruck, *Angew. Chem., Int. Ed. Engl.*, **6**, 53 (1967).
- (203) R. Mathieu and R. Poilblanc, *Inorg. Chem.*, **11**, 1858 (1972).
- (204) J. Chatt and A. G. Wedd, *J. Organomet. Chem.*, **27**, C15 (1971).
- (205) R. Mason, K. M. Thomas, and G. A. Heath, *J. Organomet. Chem.*, **90**, 195 (1975).
- (206) M. A. Bennett and P. A. Longstaff, *J. Am. Chem. Soc.*, **91**, 6266 (1969).
- (207) S. D. Ittel, C. A. Tolman, A. D. English, and J. P. Jesson, *J. Am. Chem. Soc.*, **98**, 6073 (1976).
- (208) E. L. Muetterties and J. W. Rathke, *Chem. Commun.*, 850 (1974).
- (209) J. W. Rathke and E. L. Muetterties, *J. Am. Chem. Soc.*, **97**, 3272 (1975).
- (210) H. H. Karsch, H.-F. Klein, and H. Schmidbaur, *Angew. Chem., Int. Ed. Engl.*, **14**, 637 (1975).
- (211) J. Browning, M. Green, A. Laguna, L. E. Smart, J. L. Spencer, and F. G. A. Stone, *Chem. Commun.*, 723 (1975).
- (212) T. J. DuPont, L. R. Smith, and J. L. Mills, *Chem. Commun.*, 1001 (1974); L. R. Smith and J. L. Mills, *J. Am. Chem. Soc.*, **98**, 3852 (1976).
- (213) A. J. Pryde, B. L. Shaw, and B. Weeks, *Chem. Commun.*, 947 (1973).
- (214) F. C. March, R. Mason, K. M. Thomas, and B. L. Shaw, *Chem. Commun.*, 584 (1975).
- (215) A. R. Sanger, *Chem. Commun.*, 893 (1975).
- (216) K. A. Jensen, *Z. Anorg. Chem.*, **229**, 265 (1936).
- (217) J. Chatt, N. P. Johnson, and B. L. Shaw, *J. Chem. Soc.*, 2508 (1964).
- (218) F. G. Moers, J. A. M. DeJong, and P. M. H. Beaumont, *J. Inorg. Nucl. Chem.*, **35**, 1915 (1973).
- (219) C. Masters and B. L. Shaw, *J. Chem. Soc. A*, 3679 (1971).
- (220) R. Mason, K. M. Thomas, H. D. Empsall, S. R. Fletcher, P. N. Hays, E. M. Hyde, C. E. Jones, and B. L. Shaw, *J. Chem. Soc.*, 612 (1974).
- (221) P. Heimbach, *Angew. Chem., Int. Ed. Engl.*, **3**, 648 (1964).
- (222) M. Aresta, C. F. Nobile, and A. Sacco, *Inorg. Chim. Acta*, **12**, 167 (1975).
- (223) L. Sacconi and S. Midollini, *J. Chem. Soc., Dalton Trans.*, 1213 (1972).
- (224) P. Dapporto, G. Fallini, S. Midollini, and L. Sacconi, *Chem. Commun.*, 1161 (1972).

- (225) K. Jonas and G. Wilke, *Angew. Chem., Int. Ed. Engl.*, **9**, 312 (1970).
- (226) P. Dapporto, S. Midollini, and L. Sacconi, *Inorg. Chem.*, **14**, 1643 (1975).
- (227) S. Montelactici, A. van der Ent, J. A. Osborn, and G. Wilkinson, *J. Chem. Soc. A*, 1054 (1968).
- (228) T. E. Nappier, Jr., D. W. Meek, R. M. Kirchner, and J. A. Ibers, *J. Am. Chem. Soc.*, **95**, 4194 (1973).
- (229) C. Masters, W. S. McDonald, G. Raper, and B. L. Shaw, *Chem. Commun.*, 210 (1971).
- (230) C. Masters and B. L. Shaw, *J. Chem. Soc. A*, 3679 (1971).
- (231) D. E. Budd, D. G. Holah, A. N. Hughes, and B. C. Hui, *Can. J. Chem.*, **52**, 775 (1974).
- (232) L. W. Gosser, *Inorg. Chem.*, **14**, 1453 (1975).
- (233) F. J. Hirsekorn, M. C. Rakowski, and E. L. Muetterties, *J. Am. Chem. Soc.*, **97**, 237 (1975).
- (234) J. C. Poulin, T. P. Dang, and H. B. Kagan, *J. Organomet. Chem.*, **84**, 87 (1975).
- (235) R. Baker, A. H. Cook, and T. N. Smith, *Tetrahedron Lett.*, No. 7, 503 (1973).
- (236) R. Baker, A. H. Cook, D. E. Halliday, and T. N. Smith, *J. Chem. Soc., Perkin Trans. 2*, 1511 (1974).
- (237) (a) W. Brenner, P. Heimbach, H. Hey, E. W. Müller, and G. Wilke, *Justus Liebigs Ann. Chem.*, **727**, 161 (1969); (b) P. Heimbach, *Angew. Chem., Int. Ed. Engl.*, **12**, 97 (1973); (c) B. Bogdanovic, B. Henc, H.-G. Karmann, H.-G. Nüssel, D. Walter, and G. Wilke, *Ind. Eng. Chem.*, **62** (12), 35 (1970).
- (238) F. E. Paulik, *Catal. Rev.*, **6**, 49 (1972).
- (239) E. R. Tucci, *Ind. Eng. Chem., Prod. Res. Dev.*, **9** (4), 516 (1970).
- (240) R. L. Pruett and J. A. Smith, *J. Org. Chem.*, **34**, 327 (1969).
- (241) B. M. Trost and P. E. Strege, *J. Am. Chem. Soc.*, **97**, 2534 (1975).
- (242) W. S. Knowles and M. J. Sabacky, *Chem. Commun.*, 1445 (1968).
- (243) T. P. Dang and N. B. Kagan, *Chem. Commun.*, 481 (1971).
- (244) W. S. Knowles, M. J. Sabacky, B. D. Vineyard, and D. J. Weinkauff, *J. Am. Chem. Soc.*, **97**, 2567 (1975).
- (245) R. J. Burns, P. B. Bulkowski, S. C. V. Stevens, and M. C. Baird, *J. Chem. Soc. Dalton Trans.*, 415 (1974).
- (246) B. R. James, D. K. W. Wang, and R. F. Voigt, *Chem. Commun.*, 574 (1975).
- (247) P. Pino, G. Consiglio, C. Botteghi, and C. Salomon, *Adv. Chem. Ser.*, No. **132**, 295 (1974).
- (248) R. J. P. Corriu and J. J. E. Moreau, *J. Organomet. Chem.*, **85**, 19 (1975).
- (249) (a) C. G. Swain and E. C. Lupton, Jr., *J. Am. Chem. Soc.*, **90**, 4328 (1968); (b) G. M. Bodner, *Inorg. Chem.*, **14**, 1932 (1975).
- (250) L. E. Manzer and C. A. Tolman, *J. Am. Chem. Soc.*, **97**, 1955 (1975).
- (251) L. Pauling, "The Nature of the Chemical Bond", 2nd ed, Cornell University Press, Ithaca, N.Y., 1948, p 179.
- (252) R. F. Bryan and W. C. Schmidt Jr., *J. Chem. Soc., Dalton Trans.*, 2337 (1974).
- (253) B. T. Kilbourn, U. A. Raeburn, and D. T. Thompson, *J. Chem. Soc. A*, 1906 (1969).
- (254) R. Dobson and L. W. Houk, *Inorg. Chim. Acta*, **1**, 287 (1967).
- (255) M. B. Smith and R. Bau, *J. Am. Chem. Soc.*, **95**, 2388 (1973).
- (256) S. J. LaPlaca, W. C. Hamilton, J. A. Ibers, and A. Davison, *Inorg. Chem.*, **8**, 1928 (1969).
- (257) B. A. Frenz and J. A. Ibers, *Inorg. Chem.*, **9**, 2403 (1970).
- (258) F. V. Lovecchio, E. S. Gore, and D. H. Busch, *J. Am. Chem. Soc.*, **96**, 3109 (1974).
- (259) L. Y. Martin, L. J. DeHayes, L. J. Zompa, and D. H. Busch, *J. Am. Chem. Soc.*, **96**, 4046 (1974).
- (260) H. G. Drickamer, *Comments Solid State Phys.*, **3**, 53 (1970).
- (261) H. H. Brintzinger, L. L. Lohr, Jr., and K. L. T. Wong, *J. Am. Chem. Soc.*, **97**, 5146 (1975).
- (262) (a) T. J. Marks and W. J. Kennelly, *J. Am. Chem. Soc.*, **97**, 1439 (1975); (b) R. R. Schrock, *ibid.*, **97**, 6577 (1975), and private communication.
- (263) J. P. Collman, R. R. Gagne, C. A. Reed, T. R. Halbert, G. Lang, and W. T. Robinson, *J. Am. Chem. Soc.*, **97**, 1427 (1975).
- (264) J. Ahnrog, J. E. Baldwin, and J. Huff, *J. Am. Chem. Soc.*, **97**, 227 (1975).
- (265) H. C. Clark, University of Guelph, and M. Laing, University of Natal, private communications.
- (266) C. A. Tolman, D. W. Reutter, and W. C. Seidel, *J. Organomet. Chem.*, **117**, C30 (1976), have shown in a study of reactions of Ni(COD)₂ with L that NiL₄ complexes can have steric strain energies in excess of 20 kcal/mol.
- (267) (a) R. Mason and D. W. Meek, *Acc. Chem. Res.*, submitted for publication; (b) J. Emsley and D. Hall, "The Chemistry of Phosphorus", Wiley, New York, N.Y., (1976).
- (268) (a) J. F. Blout, C. A. Maryanoff, and K. Mislow, *Tetrahedron Lett.*, 913 (1975); (b) J. F. Blout and K. Mislow, *ibid.*, 909 (1975); (c) C. A. Maryanoff and K. Mislow, private communication.
- (269) J. R. DeLerno, L. M. Trefonas, M. Y. Darenbourg, and R. J. Majeste, *Inorg. Chem.*, **15**, 816 (1976).
- (270) J. T. Gill, J. J. Mayerle, P. S. Welcker, D. F. Lewis, D. A. Ucko, D. J. Barton, D. Stowens, and S. J. Lippard, *Inorg. Chem.*, **15**, 1155 (1976).
- (271) R. Ros, M. Lenarda, N. B. Pahor, M. Calligario, P. Delise, L. Randaccio, and M. Graziani, *J. Chem. Soc., Dalton Trans.*, 1937 (1976).
- (272) T. V. Ashworth, E. Singleton, and M. Laing, *Chem. Commun.*, 875 (1976).
- (273) R. J. Cross, T. H. Green, and R. Keat, *J. Chem. Soc., Dalton Trans.*, 1424 (1976).
- (274) J. O. Albright, F. L. Tanzella, and J. G. Verkade, *J. Coord. Chem.*, **5**, 225 (1976).
- (275) R. Brady, B. R. Flynn, G. L. Geoffroy, H. B. Gray, J. Peone, Jr., and L. Vaska, *Inorg. Chem.*, **15**, 1485 (1976).
- (276) E. A. Allen and J. Del Gaudio, *J. Chem. Soc., Dalton Trans.*, 1356 (1975).
- (277) J. B. Joedicke, H. V. Studer, and J. T. Yoke, *Inorg. Chem.*, **15**, 1352 (1976).
- (278) E. J. Lukosius and K. J. Coskran, *Inorg. Chem.*, **14**, 1922 (1975).
- (279) P. Uguagliati, B. Crociani, U. Belluco, and L. Calligaro, *J. Organomet. Chem.*, **112**, 111 (1976).
- (280) Y. Nakamura, K.-I. Maruya, and T. Mizoroki, *J. Organomet. Chem.*, **104**, C5 (1976).
- (281) S. J. Anderson, P. L. Goggin, and R. J. Goodfellow, *J. Chem. Soc., Dalton Trans.*, 1959 (1976).
- (282) H. Hoffmann and P. Schellenbeck, *Chem. Ber.*, **100**, 692 (1967).
- (283) D. B. Denney and D. H. Jones, *J. Am. Chem. Soc.*, **91**, 5821 (1969).
- (284) L. L. Cheng and D. B. Denney, *Phosphorus*, **6**, 69 (1975).
- (285) H. D. Empsall, E. M. Hyde, E. Mentzer, B. L. Shaw, and M. F. Uttley, *J. Chem. Soc., Dalton Trans.*, 2069 (1976).
- (286) S. Otsuka, T. Yoshida, M. Matsumoto, and K. Nakatsu, *J. Am. Chem. Soc.*, **98**, 5850 (1976).
- (287) C. J. Moulton and B. L. Shaw, *Chem. Commun.*, 365 (1976).
- (288) C. A. Tolman, L. W. Yarbrough II, and J. G. Verkade, *Inorg. Chem.*, **16**, 479 (1977).
- (289) A. D. English, C. A. Tolman, S. D. Ittel, and J. P. Jesson, to be published.
- (290) A. D. English, J. P. Jesson, and C. A. Tolman, *Inorg. Chem.*, **15**, 1730 (1976).
- (291) P. A. Wegner, L. F. Evans, and J. Haddock, *Inorg. Chem.*, **14**, 192 (1975).
- (292) S. Yoshikawa, K. Aoki, J. Kiji, and J. Furukawa, *Bull. Chem. Soc. Jpn.*, **48**, 3239 (1975).
- (293) S. Yoshikawa, J. Kiji, and J. Furukawa, *Bull. Chem. Soc. Jpn.*, **49**, 1093 (1976).
- (294) Von F. Brille, P. Heimbach, H. Schenkluhn, and B. Weimann, private communication from P. Heimbach.
- (295) J. X. McDermott, J. F. White, and G. M. Whitesides, *J. Am. Chem. Soc.*, **98**, 6521 (1976).
- (296) P. E. Garrou and G. E. Hartwell, *Inorg. Chem.*, **15**, 730 (1976).
- (297) T. J. Marks and G. W. Grynkewich, *Inorg. Chem.*, **15**, 1302 (1976).
- (298) P. J. Davidson, D. H. Harris, and M. F. Lappert, *J. Chem. Soc., Dalton Trans.*, 2268 (1976), and following papers.